

# ALUMINUM HORIZONTAL BLINDS

## TABLE OF CONTENTS

<b>BLIND FEATURES AND SIZE CONSIDERATIONS</b>		<b>PAGE</b>
Blind Features . . . . .		2
Corded Blinds: Size Considerations and Depth Requirements . . . . .		3
Cordless Blinds: Size Considerations and Depth Requirements . . . . .		4
<b>BLIND OPTIONS</b>		
Blind Options Chart . . . . .		5
Standard Cord Control . . . . .		6
Cordless Lift System . . . . .		6
Motorization . . . . .		7
Hidden Holes . . . . .		8
Inverted Slats . . . . .		8
Multiple Blinds on One Headrail . . . . .		9
Multi-colored Striped Blinds . . . . .		10
Cloth Tapes and Colors . . . . .		10
Cut-out Blinds . . . . .		11
Bay and Corner Windows . . . . .		12
Specialty Shapes: Skylights Dual Headrail or Incline Wire Blinds . . . . .		13-14
Specialty Shapes: Arches . . . . .		15
Specialty Shapes: Circles . . . . .		15
Specialty Shapes: Side Cuts, Angle Top and Bottom . . . . .		16
Specialty Shapes: Octagons, Triangles and Other Shapes . . . . .		17
Making a Template for Specialty Shapes . . . . .		18
Using the Template Service . . . . .		18
<b>GENERAL INFORMATION</b>		
Aluminum Color Assortment . . . . .		19
Color Coordination Chart: ½" & 1" Aluminum . . . . .		20
Color Coordination Chart: 2" Grandeur™ Aluminum . . . . .		21
Ladder Color Coordination: Skylight Blinds, Dual Headrail and Incline Wire . . . . .		21
Stack Height Chart . . . . .		22
Slat Count Chart . . . . .		23
Slat Rout and Ladder Count Chart . . . . .		24-25
½" Micro Supreme Aluminum Blind Product Detail . . . . .		26
1" Supreme Aluminum Blind Product Detail . . . . .		26
1" Cordless Supreme Aluminum Blind Product Detail . . . . .		27
1" Classics Aluminum Blind Product Detail . . . . .		28
1" Insignia® Aluminum Blind Product Detail . . . . .		29
2" Grandeur™ Aluminum Blind Product Detail . . . . .		29
<b>PRICE CHARTS AND OPTIONS PRICING</b>		
Price Group A: 1" Cordless Supreme Aluminum Blinds . . . . .		31
Price Group B: 1" Supreme Mini Aluminum Blinds . . . . .		32
Price Group C: 1" Classics Mini Aluminum Blinds . . . . .		33
Price Group D: 1" Insignia® Mini Aluminum Blinds . . . . .		34
Price Group E: ½" Micro Supreme Aluminum Blinds . . . . .		35
Price Group F: 2" Grandeur™ Aluminum Blinds . . . . .		36
Price Group G: Specialty Shape: Incline Wire . . . . .		37
Price Group H: Specialty Shape: Incline Wire – Side Cuts, Inverted Triangles, Angle Tops and Bottoms . . . . .		38
Price Group H: Specialty Shape: Incline Wire – Octagons, Triangles and Other Shapes . . . . .		39
Price Group I: Specialty Shape: Arches . . . . .		40
Price Group J: Specialty Shape: Circles . . . . .		41
Price Group K: Specialty Shape: Side Cuts, Angle Top and Bottom . . . . .		42
Price Group L: Specialty Shape: Octagons, Triangles . . . . .		43
Options Pricing . . . . .		44



# Blind Features

## 1" SUPREME CORDLESS

- Great for children's rooms and play areas
- Choose .006 or .008 gauge 1" aluminum slats
- Cordless system allows blind to be raised and lowered easily with the touch of a finger
- Improved safety for households with children and pets
- Eliminates unsightly cords
- Hidden Holes™ option for additional light control and privacy
- Patented, sleek headrail design features a light-blocking lip, requires no valance (1½" x 2¾" aluminum)
- Hidden headrail brackets reduce light gaps
- Gear-driven motor provides smooth, quiet operation
- Our painting process makes slats resist dust, stains, scratches, mold and mildew
- Color-coordinated components provide a finished look
- Cordless handle keeps the blind clean

## 1" SUPREME

- The ultimate in light control
- Choose .006 or .008 gauge 1" aluminum slats
- Offers the most options in color to suit any decor
- Sleek lightblocking headrail requires no valance (1" x 1½" steel)
- Tighter ladder spacing provides greater light-blocking ability
- Hidden headrail brackets reduce light gaps
- Hidden Holes™ option for additional light control and privacy
- Clutch wand tilt releases to prevent damage
- Crash proof cordlock and bottomrail bumpers prevent sill damage
- Precision machined roller system makes it easier to raise blinds
- Our painting process makes slats resist dust, stains, scratches, mold and mildew
- Color-coordinated components provide a finished look

## 1" CLASSICS

- Box brackets make it a snap to install
- Available in skylights and other specialty shapes
- Choose .006 or .008 gauge 1" aluminum slats
- 1" x 1½" steel rectangular headrail
- Deluxe two-slat valance provides a more attractive look
- Clutch wand tilt releases to prevent damage
- Crash proof cordlock and bottomrail bumpers prevent sill damage
- Less porous paint on slats resists dust, stains, scratches, mold and mildew
- Color-coordinated components provides a finished look

## 1" INSIGNIA®

- Your best value
- Fits in windows with narrow jams
- .006 gauge 1" aluminum slats
- 1" x 1" steel square headrail requires minimal depth for a flush mount
- Box brackets make it a snap to install
- Two-slat valance provides a more attractive look
- Clutch wand tilt releases to prevent damage
- Crash proof cordlock prevents sill damage
- Our painting process makes slats resist dust, stains, scratches, mold and mildew



## ½" SUPREME MICRO

- Great for French doors and small windows
- .006 gauge ½" aluminum slats
- Sleek lightblocking headrail requires no valance (1" x 1½" steel)
- Hidden headrail brackets reduce light gaps
- Clutch wand tilt releases to prevent damage
- Our painting process makes slats resist dust, stains, scratches, mold and mildew
- Color-coordinated components provide a finished look

## 2" GRANDEUR™

- Proportionate for large windows
- Maximizes view to outside when slats are open
- .008 gauge 2" aluminum slats
- Patented SureTight® headrail (1⅜" x 2¼") with premium light-blocking features
- Box brackets make it a snap to install
- Decorative cloth tapes available
- Deluxe channel panel valance provides a sleek finished look
- Crash proof cordlock prevents sill damage
- Our painting process makes slats resist dust, stains, scratches, mold and mildew
- Color-coordinated components provide a finished look

# Size Considerations

CORDED BLINDS										
										
		STANDARD BLIND				CORDED MULTIPLE BLINDS ON ONE HEADRAIL				
		WIDTH		HEIGHT		WIDTH			HEIGHT	
STYLES	Price Group	Min*	Max	Min	Max	Min Panel*	Max Panel	Max Blind	Min Blind	Max Blind
1/2" Micro Supreme	E	5 1/2" Δ	120"	6"	5 1/2" - 22": 96" <sup>β</sup> 22 1/6" - 120": 144"	9"	120"	192"	6"	108"
1" Classics	C	5 1/2" Δ	142"	6"	126"	9"	142"	192"	6"	126"
1" Insignia®	D	5 1/2" Δ	120"	6"	126"	9"	142"	192"	6"	126"
1" Supreme 6g & 8g	B	5 1/2" Δ	142"	6"	5 1/2" - 11 15/16": 132" 12" - 35": 168" 35 1/6" - 143 3/4": 240"	9"	142"	192"	6"	126"
2" Grandeur™	F	9"+	142"	10"	126"	9"+	142"	142"	10"	126"

\* For all inside mount applications—1/2" deduction is taken by manufacturer on overall width; Supreme and Supreme Micro—3/8"

Δ 5 1/2" to 8 15/16" center tilt only

† 9" outside mount, 9 1/2" inside mount (9" to 11 15/16" center tilt only)



12" to 16" (Standard or Reversed Standard controls)

16 1/6" (Same side controls)

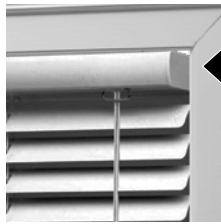
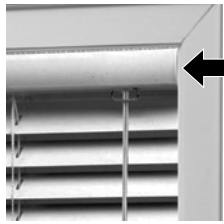
β Blind width 5 1/2" - 22": 96"; Blind width 22 1/6" - 120": 144"

DEPTH REQUIREMENTS FOR INSIDE MOUNT			
			
		Partially recessed headrail in window casing/molding	Fully recessed headrail in window casing/molding
Blind Type	Headrail Dimensions	Minimum Depth Mount	Flush with Casing
1/2" Micro Supreme	1" x 1 1/2"	3/4"	1 3/4"
1" Classics	1" x 1 1/2"	3/4"	1 7/8"
1" Insignia	1" x 1"	3/4"	1 5/8"
1" Supreme	1" x 1 1/2"	3/4"	1 3/4"
2" Grandeur	1 5/8" x 2 1/4"	3/4"	2 3/8"

# Size Considerations

CORDLESS BLINDS												
												
		CORDLESS BLIND				CORDLESS MULTIPLE BLINDS ON ONE HEADRAIL						
		WIDTH		HEIGHT		WIDTH			HEIGHT			
STYLES	Price Group	Min*	Max	Min	Max	Min Panel	Max Panel	Max Blind	Min Blind	Max Blind		
1" Supreme 6g	B	18"	96"	12"	84" Standard 72" Hidden Holes	18"	60"	120" (2 on 1) 144" (3 on 1)**	12"	72"		
1" Supreme 8g	B											

\* For all inside mount applications— $\frac{3}{8}$ " deduction is taken by manufacturer on overall width

\*\*The control for the center panel on a three on one cordless blind will always be on the left.

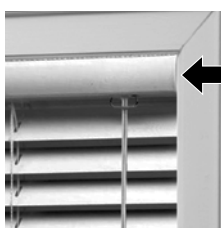
DEPTH REQUIREMENTS FOR INSIDE MOUNT			
			
		Partially recessed headrail in window casing/molding	Fully recessed headrail in window casing/molding
		Corded headrail shown	Corded headrail shown
Blind Type	Headrail Dimensions	Minimum Depth Mount	Flush with Casing
Supreme	1" X $2\frac{3}{16}$ "	$\frac{3}{4}$ "	2 $\frac{1}{8}$ "
Privacy Supreme			

# Blind Options

**BLIND OPTIONS: FOR SURCHARGES AND PRICING REFER TO PRICING SECTION**

The following is a chart of options for ½", 1" and 2" Aluminum Blinds. Options that are available vary by blind type. See specific option for availability and detailed descriptions on the following pages.

Features	Classics	Insignia®	1" Supreme	1" Supreme Cordless	½" Supreme Micro Aluminum	2" Grandeur™ Aluminum
Bay or Corner Window	✓	✓	✓	✓	✓	✓
Cloth Tapes						✓
Control Location:						
Standard (Tilt left, lift right)	✓	✓	✓	Tilt left	✓	✓
Reverse	✓	✓	✓	Tilt right	✓	✓
Same Side	Over 13¾"	Over 11 <sup>15</sup> / <sub>16</sub> "	Over 11 <sup>15</sup> / <sub>16</sub> "		Over 11 <sup>15</sup> / <sub>16</sub> "	Over 16"
Cut-Outs – to work around any architectural detail	✓	✓	✓		✓	✓
Double Slats	✓		✓			
Hidden Holes – for additional privacy, light control and a cleaner look			✓	✓		
Inverted Slat – to bring more light into the room	✓	✓	✓	✓		✓
Limited Tilt	✓	✓	✓		✓	
Motorized Tilt (see Motorization tab)						✓
Multiple Blinds on One Headrail – for large windows	✓	✓	✓	✓	✓	✓
Multi-Colored Striped Blinds – perfect for themed rooms	✓		✓	✓	✓	✓
Projection Brackets – 1¾", 2¾", 4¾"	✓	✓	✓	✓	✓	✓
Side Mount	Standard	Standard	✓		✓	Standard
Sky poles – for hard to reach controls, used with Ring Tilt or Ring Pull						
3-6½ ft	✓		✓	✓	✓	✓
5-9½ ft	✓		✓	✓	✓	✓
Tilt:						
Cord Tilt	✓					Standard
Wand Tilt	Standard	Standard	Standard	Standard	Standard	✓
Ring Tilt & Ring Pull – 6"	✓		✓		✓	✓
Toplock Cord Lock	✓	✓	✓		✓	

# Blind Options

## STANDARD CORD CONTROL



### Wand Tilt

- **No charge**
- Standard



2" Grandeur  
Shown

### Cord Tilt

- **No charge**
- Standard on 2" Grandeur
- Optional on Classic



### Ring Tilt and Ring Pull

- **No charge**
- Optional
- Not available on Cordless
- Optional Sky Pole available—for surcharge, see Options Pricing
- Sky Pole not available on Insignia
- Ring Pull standard length is 6" (not available from 6 $\frac{1}{16}$ " - 7 $\frac{15}{16}$ " )

## CORDLESS LIFT SYSTEM



### • **For surcharge, see Price Charts**

- Great for kids' rooms – improved safety
- Choose .006 or .008 gauge 1" aluminum slats
- Cordless system allows blind to be raised and lowered easily with the touch of a finger
- Cordless handle keeps the blind clean
- Eliminates unsightly cords
- Patented, sleek headrail design features a light-blocking lip, requires no valance (1 $\frac{1}{2}$ " x 2 $\frac{3}{16}$ " aluminum)
- Hidden headrail brackets reduce light gaps
- Gear-driven motor provides smooth, quiet operation
- Our painting process makes slats resist dust, stains, scratches, mold and mildew
- Color-coordinated components provide a finished look
- Choose the Hidden Holes option for more light control and privacy
- Not available with side mount brackets

# Blind Options

## MOTORIZED TILT CONTROL



Minimum Width	19"
Maximum Width	84"
Maximum Height	126"
Maximum Size	7,200 sq. in.

- **For surcharge, see Motorization tab**
- 2" Grandeur™ only
- Radio Frequency (RF) only
- RF motorization allows blind operation from virtually anywhere in the house without direct line of sight
- Tilts slats on multiple blinds simultaneously or individually
- Remotes, wall switches and timers available with RF motorization
- Offers enhanced security with the optional wireless RF Timer
- Tilt slats when entering or exiting a room with optional wireless wall switches

Follow these steps to determine if your blinds can be motorized:

1. Measure blind width and height.
2. Make sure measurements are within minimum and maximum size specifications listed to the left.
3. Multiply width times height. Round each dimension up to nearest inch for easy calculation to obtain blind size in square inches.
4. Make sure your calculations do not exceed the maximum size specifications listed.
5. Multiple blinds on one headrail are allowed if total size is under 7,200 sq. in. All blinds will operate together with one motor.

**Example:**

- 84" wide x 96" high = 8,064 sq. in. (over max. size)
- 18" wide x 62" high = 1,116 sq. in. (under min. width)
- 67" wide x 84" high = 5,628 sq. in. (ok)

# Blind Options

## HIDDEN HOLES



Standard



1" Hidden Holes

- **For surcharge, see Price Charts**

- Provides a sleek, elegant look to Graber® 1" Supreme and Cordless Supreme mini blinds
- Smaller rout holes are placed further back on the blinds so they disappear when the blinds are closed, eliminating annoying light gaps
- Sleek, light blocking headrail is standard and gives the ultimate in privacy and light control

Note: This option may cause the bottom of the blind to touch the window when raised. Consider ordering projection brackets if this is a concern.

## INVERTED SLATS

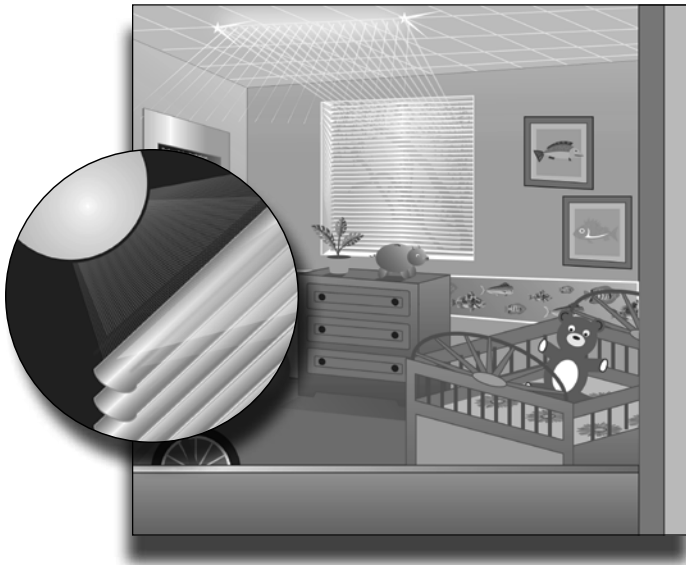

- **For surcharge, see Options Pricing**

- Bring up to 38% more daylight into your room by choosing the inverted slat option\*
- Choose Polished Aluminum (741) for optimum light
- Reflective surface throws more natural light into your room
- Available on 1" and 2" styles; not available on ½" Supreme Micro

\* 2" inverted slat in Polished Aluminum tested 38% more effective transmitting daylight into room than standard 2" slat in Polished Aluminum.



# Blind Options

## MULTIPLE BLINDS ON ONE HEADRAIL



• **For surcharge, see Price Charts**

Two or three blinds can be installed on a single headrail to provide a practical treatment for larger windows or sliding patio doors.

**Options: Standard Controls**

Two on One Headrail	Left panel	Tilt/left - lift/left
	Right panel	Tilt/right - lift/right
Three on One Headrail	Left panel	Tilt/left - lift/left
	Center panel	Tilt/left - lift/right
	Right pane	Tilt/right - lift/right

The tilt control on cordless three on one headrail will always be on the left for the center panel. Non-standard control positions can be requested.

**Measuring:**

1. Measure overall width of the area to be covered. If space permits, an overlap of 1½" per side is recommended for outside mounts.
2. Measure the width of the area each blind is to cover. Measure and specify the left blind first, continuing to the right. Allow a minimum of ¼" between blinds for operating clearance. **Note: Cordless has minimum ⅜" gap.**
3. Total width of all blinds, plus clearance(s) must equal overall width.
4. Measure height as follows:
  - a. For windows, use standard inside or outside measuring procedures.
  - b. For patio doors, measure height within ¾" of floor, either from ceiling or a point at least 6½" above the door frame. (Check slat count tables if blind is to completely clear the doorway.)

**Ordering**

1. Indicate blinds that are to be mounted on one headrail.
2. Specify total width of headrail. (For inside mount that is the total window opening.)
3. Indicate each panel size, specify left blind first, continuing to the right.
4. Specify gaps.
5. Specify control positions, if other than standard.
6. Add applicable surcharge.

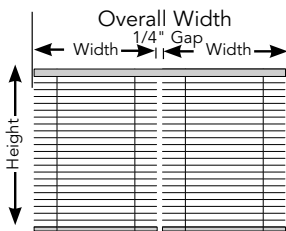

**Two Blinds on one Headrail**

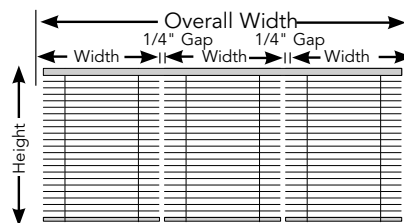

**Three Blinds on one Headrail**

**NOTE: Cordless multiple blinds have a ⅜" gap between blinds.**

# Blind Options

## MULTI-COLORED STRIPED BLINDS

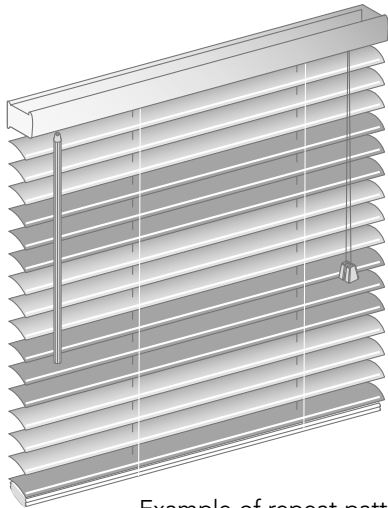

Example of repeat pattern:

- 3 slats – 2085 Real Red
- 3 slats – 2205 White Satin
- 3 slats – 2089 True Blue
- 3 slats – 2085 Real Red
- 3 slats – 2205 White Satin
- 1 slats – 2089 True Blue

- **For surcharge, see Options Pricing**
- Multi-colored blinds are the combination of two or more colors on one blind
- Headrail, bottomrail and installation brackets will match the color of the top slat
- Maximum of 5 colors can be used in a repeated or exact striped design
- Ladder supports and lifts will be color-coordinated to the headrail color
- Contact Customer Service to change color coordination
- Not available on 1" Insignia

### Specifying Colors:

1. Make a diagram of the blind, showing height.
2. From the slat count table, determine the total number of slats.
3. Bottomrail will match the color of the last slat if color pattern consists of at least 4 color slats in each color group. Otherwise, it will be the color of the headrail.

### Ordering:

1. Please specify if an Exact or Repeat pattern.  
Repeat: Color order repeats in a pattern  
Exact: Color order is specifically defined; not in a repeated pattern
2. May specify headrail, bottomrail, ladder, and cord colors

### Example of Repeat pattern:

Multi-Color Diagram (sample of 1" Supreme Aluminum)

Height = 14"

Total Slats = 16

## CLOTH TAPES AND COLORS

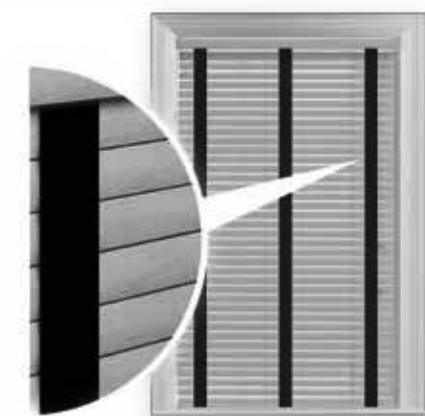

- **For surcharge, see Price Charts**
- Add a decorative touch with cloth tapes
- Only available on 2" Grandeur Aluminum Blinds
- Colors available:

1" Solid Tapes		1½" Solid Tapes	
Bamboo	1601	Beige	2011
Cocoa	1297	Black	2033
Duck White	1136	Chocolate	2353
Gloss White	1005	Cocoa	2297
White Smoke	1617	Duck White	2136
		Forest	2234
		Light Beige	2137
		Maroon	2360
		Moss	2500
		Navy	2369
		Taupe	2659
		Toffee	2296
		Wheat	2710
		White	2005
		White Smoke	2617

# Blind Options

## CUT-OUT BLINDS

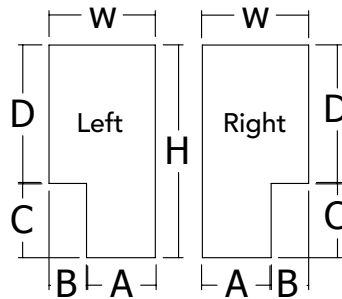
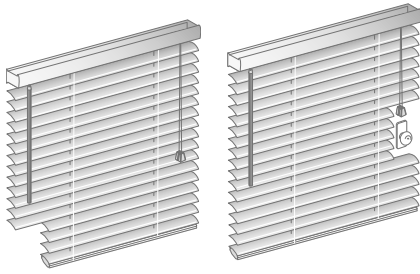

- For surcharge, see Options Pricing
- Cut-outs are not available on Cordless Blinds.

### Bottom Corner and Side (Door knob):

1" and ½" Aluminum: Maximum cut-out is blind width minus 10". A cut-out over 10" requires an intermediate rail.

2" Vinyl and Aluminum: Maximum cut-out is 1" before the rout hole.

"A" minimum is 5".

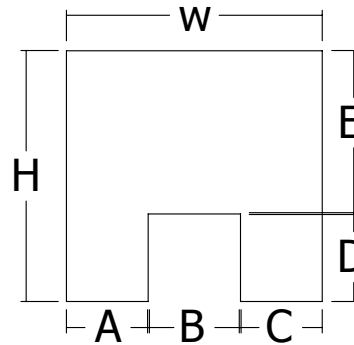
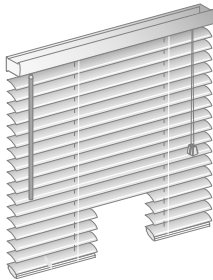

### Bottom Center:

"A" and "C" minimum is 5".

If "B" is greater than 10", there will be an intermediate rail.

NOT AVAILABLE ON 2" BLINDS.

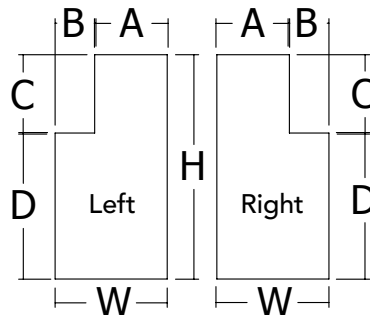
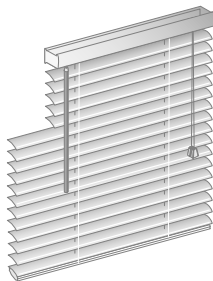

### Top Corner:

Maximum cut-out is width is limited to 1/4 of total blind width.

"A" minimum is 14".

"B" is limited to ¼ total blind width.

If "B" is greater than 8" there will be an intermediate rail.

NOT AVAILABLE ON 2" BLINDS.

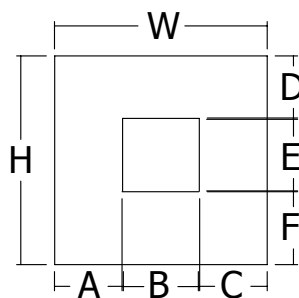
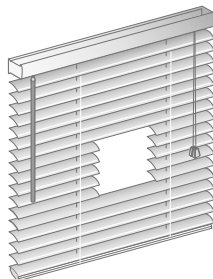

### Interior:

Both "A" and "C" minimum width is 5".

Maximum width for B is blind width minus 20".

NOT AVAILABLE ON 2" BLINDS.

**Note:** Oversized cut-out could require an intermediate support rail.  
Slats will not lift below intermediate rail.

# Blind Options

## BAY AND CORNER WINDOWS

- Made as individual blinds to fit in bay or corner windows
- Each section will have its own control; we recommend opposite corners
- Indicate each blind with bypass or butt. Bypass is the blind mounted into the corner. Butt is the blind butted up to the other blind.

- Manufacturer will take appropriate deductions for proper fit
  - Cornices are not available
- Note: If you do not want vendor to take deductions  
DO NOT order as Bay or Corner.

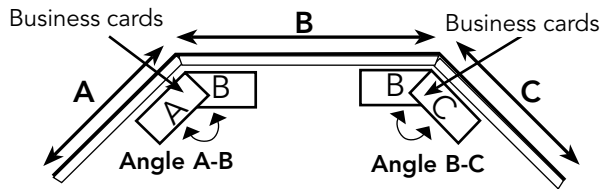
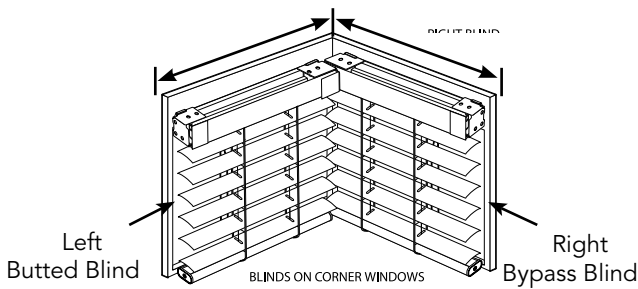

### Measuring Information

#### Corner Window

Measure:

Width of each window from corner to the point you would like to cover.

#### Three-sided Bay Window

Measure:

A & C: Width of side windows from the corners to the point you would like the blind to cover.

B: Width of the center window from corner to corner.

Angle A-B: Angle between windows (A) and (B).

Angle B-C: Angle between windows (B) and (C).

#### Four-sided Bay Window

Measure:

A & D: Width of side windows from the corners to the point you would like the blind to cover.

B & C: Width of each window from corner to corner.

Angle A-B: Angle between windows (A) and (B).

Angle B-C: Angle between windows (B) and (C).

Angle C-D: Angle between windows (C) and (D).

#### Five-sided Bay Window

Measure:

A & E: Width of side windows from the corners to the point you would like the blind to cover.

B, C & D: Width of each center window from corner to corner.

Angle A-B: Angle between windows (A) and (B).

Angle B-C: Angle between windows (B) and (C).

Angle C-D: Angle between windows (C) and (D).

Angle D-E: Angle between windows (D) and (E).

**NOTE:** Measure bay angle using protractor or angle finder, or use two business cards in bay corner as illustrated above and fax to customer service.

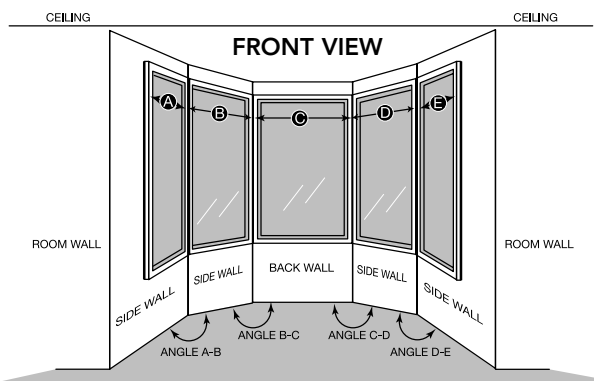
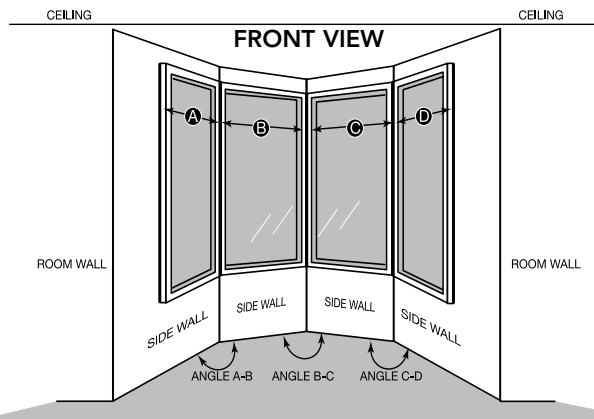

# Blind Options

## SPECIALTY SHAPES: SKYLIGHTS DUAL HEADRAIL OR INCLINE WIRE BLINDS

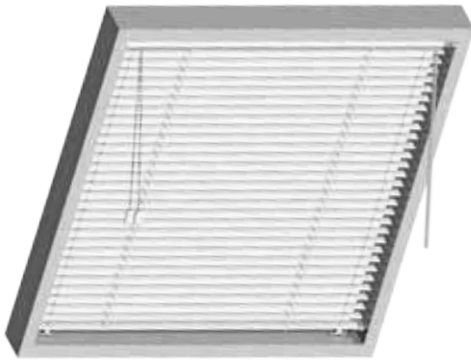

### Incline Wire Features

- For surcharge, see Price Charts
- Degree from vertical cannot exceed 45 degrees
- Available in all specialty shapes except arches and circles
- Choose .006 or .008 gauge 1" aluminum slat
- 1" x 1½" steel headrail, box design
- Wand tilt left (standard) or right
- Lift cord right (standard) or left
- Color-coordinated components provide a finished look
- Sky poles available for easy tilting upon request
- Blinds inclined over 30 degrees from vertical will have marginal tilt operation
- Blinds inclined over 40 degrees from vertical will lower marginally
- Available in special shapes (exception: Arch and Circle)

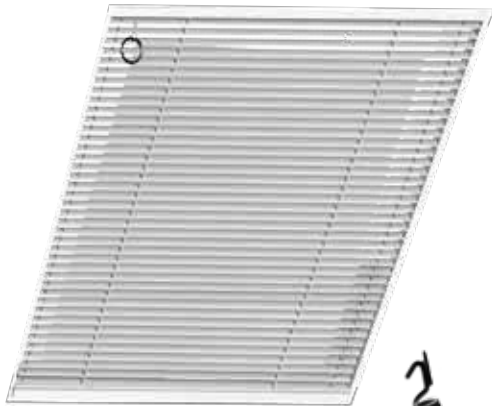

### Dual Headrail Features

- For surcharge, see Price Charts
- For windows at more than a 45 degree angle
- Blinds are tilt only
- Choose .006 or .008 gauge 1" aluminum slat
- 1" x 1½" steel headrail, box design
- Ring tilt left (standard) or right
- Color-coordinated components provide a finished look
- Sky poles available for easy tilting upon request



Sky Pole

	Incline Wire		Dual Headrail	
Minimum Width	9" exact		9"	
Maximum Width	122" "		142"	
Minimum Height	10"		10"	
Maximum Height	Blind Width	Max Height	Blind Width	Max Height
	9" - 32"	126"	9" - 23"	126"
	32½" - 57"	108"	23½" - 32"	102"
	57½" - 92"	102"	32½" - 72"	90"
	92½" - 122"	90"	72½" - 142"	80"

# Blind Options

## SPECIALTY SHAPES: SKYLIGHTS DUAL HEADRAIL OR INCLINE WIRE BLINDS

### Measuring Information

#### Inside Mount

- A. Width** – Measure the exact inside width of the window casing from one inside edge to the other in three different places. Record the **narrowest** measurement.
- B. Height** – Measure the exact height in three different places from the top edge of the opening to the top of the sill. Record the **longest** measurement.

Do **not** deduct for headrail clearance gaps. Manufacturer will make all allowances for both width and height. Headrail, tension rail and slats will be manufactured 1/2" less than the dimension given as width. Proper deductions will be made for blind height.

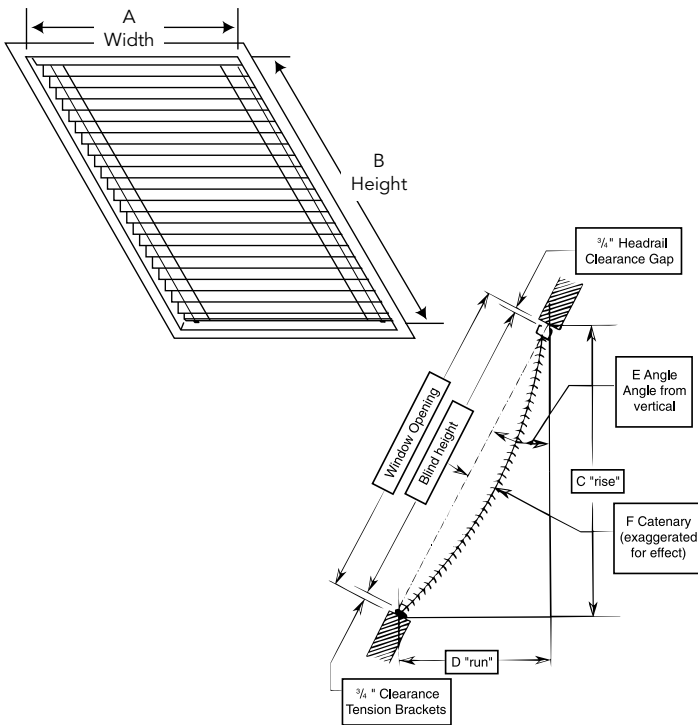

#### Outside Mount

Measure width and height dimensions and specify as "blind size, cut exact". The manufacturer will **not** make any allowances for width or height. Headrail, tension rail and slats will equal dimensions given as width. Blind height will refer to the distance from the top of the upper bracket to the lower bracket of the installed blind and will equal dimension given as height. Do not deduct for headrail and tension rail clearance gaps.

### Incline Wire Skylight

Ideal for skylights at up to a 45 degree angle.

**NOTE: Blinds can lift and tilt.**

**Used in windows installed vertically to 45 degrees from vertical (maximum).**

- A. Width** – Measure the exact inside width of the window casing from one inside edge to the other in three different places. Record the **narrowest** measurement.
- B. Height** – Measure the exact height in three different places from the top edge of the opening to the top of the sill. Record the **longest** measurement.
- C. Rise** – The vertical measurement from the top of a window to the RUN to form a 90 degree angle.
- D. Run** – The horizontal measurement from the bottom of a window to the RISE to form a 90 degree angle.
- E. Angle** – The degree the window is slanted perpendicular (at a right angle) to the floor.
- F. Catenary** – The degree a blind may possibly bow. No measurement needed.

Must give measurements for A and B. C and D are used to calculate the angle (must be less than 45 degrees)

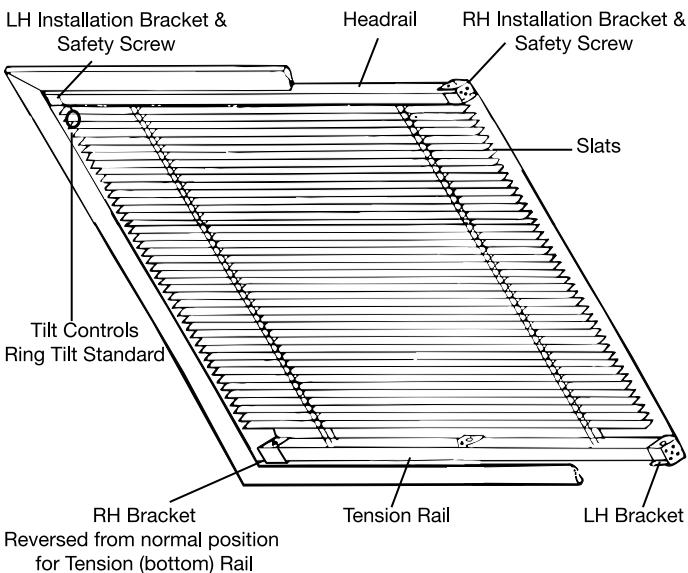

### Dual Headrail Skylight

Ideal for skylights at more than a 45 degree angle.

**NOTE: Blind is tilt only, no lift.**

# Blind Options

## SPECIALTY SHAPES: ARCHES

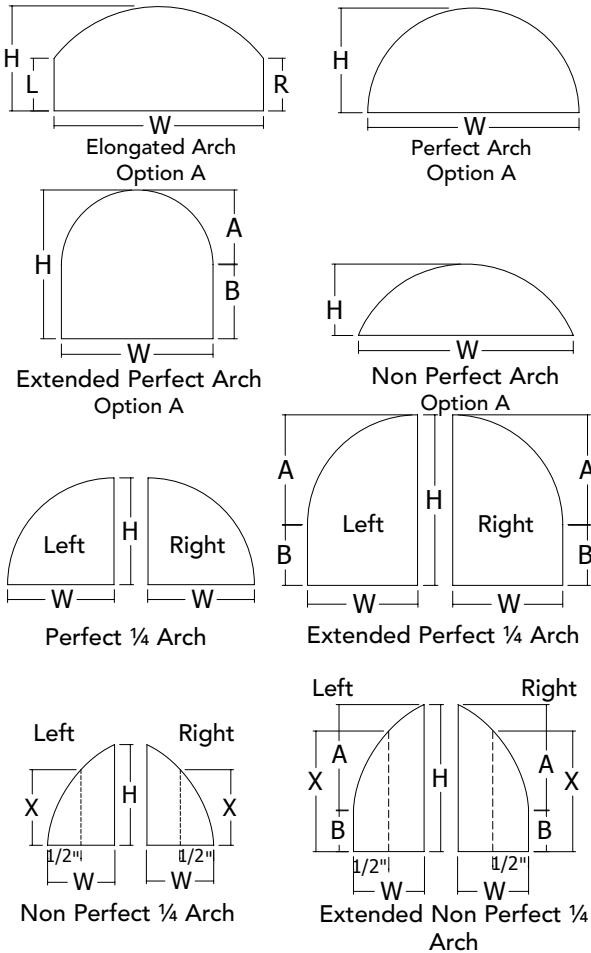

All Quarter Arches  
Left Side: Option F Right Side: Option G

- For surcharge, see Price Charts
- Choose .006 or .008 gauge 1" aluminum slat
- Use 1" x 1" aluminum headrail
- Valance not available
- A template is required for all arches except Perfect Arches
- Limitations may apply within each blind type. Fax a drawing to Customer Service to determine availability
- May require 4-6 weeks lead time to manufacture

### Size Considerations

	Arches	Quarter Arch
Minimum Width	10"	12¾"
Maximum Width	Base 142"	142"
Minimum Height	5"	6"
Maximum Height	126"	126"

### Controls

Arches: Standard, Reverse or Same Side  
Quarter Arch: Low Side  
Full Tilt: Lift depends on shape  
Cord Tilt and Ring Tilt: Not Available

### Ordering Information

**Full Arch:** To order, choose specialty option A  
**Quarter Arches:** Choose specialty option F for Left Quarter Arch and option G for Right Quarter Arch

Only available on 1" Classics Blinds

## SPECIALTY SHAPES: CIRCLES

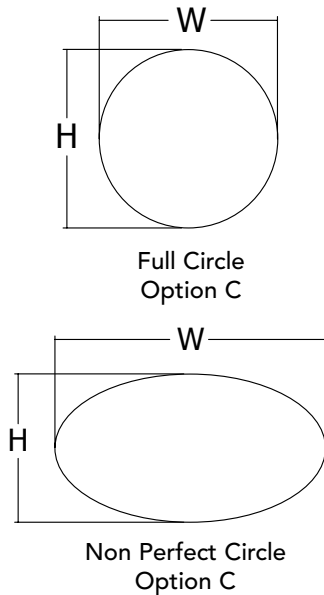

- For surcharge, see Price Charts
- Choose .006 or .008 gauge 1" aluminum slat
- An illustration can be resized
- Uses 1" x 1" aluminum headrail
- Valance not available
- A template is required for all non perfect circles (see Instructions for making a template)
- Limitations may apply within each blind type. Fax a drawing to Customer Service to determine availability
- May require up to 4-6 weeks lead time to manufacture

### Size Considerations

Minimum Width	12" diameter
Maximum Width/Height	72"

### Controls

Controls: Left or Right  
Full tilt: No lift  
Cord Tilt and Ring Tilt: Not available

### Ordering Information

**Circles:** To order, choose specialty option C

# Blind Options

## SPECIALTY SHAPES: SIDE CUTS, ANGLE TOP AND BOTTOM

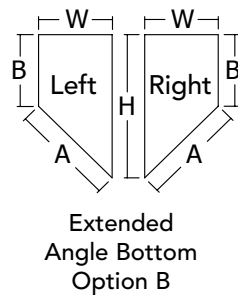
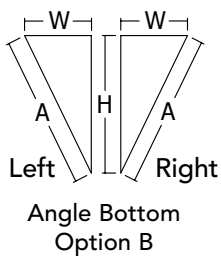
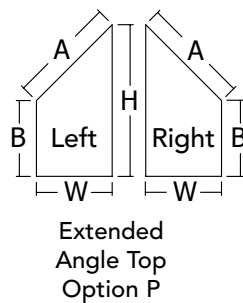
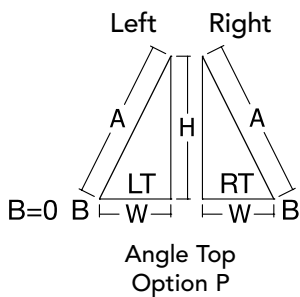
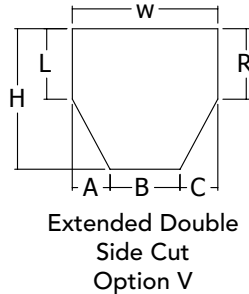
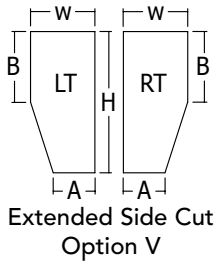
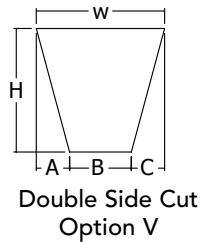
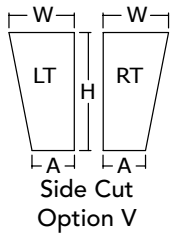

**For surcharge, see Price Charts**

- Choose .006 or .008 gauge 1" aluminum slat
- An illustration can be reversed or resized
- Use 1" x 1½" steel headrail
- Valance not available
- Limitations may apply within each blind type. Fax a drawing to Customer Service to determine availability.
- May require up to 4-6 weeks lead time to manufacture
- To order, fax a signed drawing with all dimensions to customer service
- Available as Incline Wire for Skylights

**Size Considerations**

	Side Cuts	Angle Top and Bottom
Minimum Bottom Rail	4½" Exact	12" Exact
Maximum Width	142"	142"
Minimum Height	6"	12"
Maximum Height	126"	126"
Minimum Headrail	7½"	12"

**Controls**

Side Cuts: Standard, Reverse or Same Side  
(straight side only)

Angle Bottoms: Standard, Reverse or Same Side (dependent on shape)

Angle and Extended Angle Tops & Bottoms: Cord Lock must be Low Side

Full Tilt: Lift depends on shape

Cord Tilt: Available (not available with Incline Wire)

Angle Bottoms: 60° maximum angle degree. For greater than 60°; order side cut, bottom point will have light gap.

**Ordering Information**

Choose specialty option indicated below illustration.



# Blind Options

## SPECIALTY SHAPES: OCTAGONS, TRIANGLES AND OTHER SHAPES

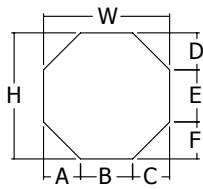

Octagon  
Option U

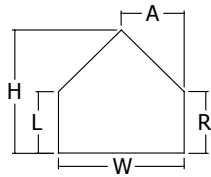

Extended Triangle  
Option T

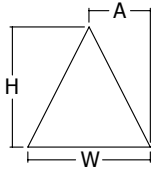

Triangle  
Option I

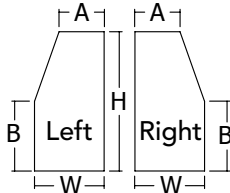

Extended  
Inverted Side Cut  
Option I

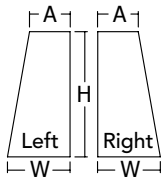

Inverted Side Cut  
Option I

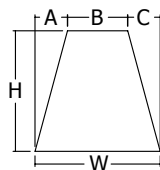

Inverted Double  
Side Cut  
Option I

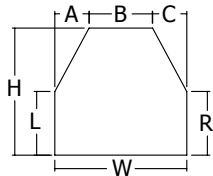

Extended Inverted  
Double Side Cut  
Option I

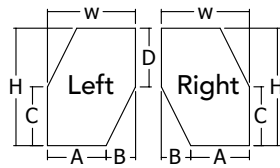

Extended  
Offset Cut  
Option I

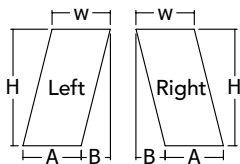

Offset Cut  
Option I

- For surcharge, see Price Charts
- Choose .006 or .008 gauge 1" aluminum slat
- An illustration can be inverted or reversed or resized
- Headrail is split on many of these shapes
- Use 1" x 1½" steel headrail
- Valance not available
- Limitations may apply within each blind type. Fax a drawing to Customer Service to determine availability
- May require up to 4-6 weeks lead time to manufacture
- To order, fax a signed drawing with all dimensions to Customer Service
- Available as Incline Wire for Skylights

### Size Considerations

	Octagon	Triangle	Other Shapes
Minimum Width	7½" Exact Head Rail	12"	7½" Exact Head Rail
Maximum Width	142" or 192" maximum total combined headrail segments		
Minimum Height	18⅞"	12"	12"
Maximum Height	126"	126"	126"

### Controls

- Controls: Standard, Reverse or Same Side (straight side only)
- Full Tilt Left or Right: Lift depends on shape
- Limited Tilt: Available
- Cord Tilt: Available (not available with Incline Wire)

### Ordering Information

Choose specialty option indicated below illustration.

# Blind Options

## MAKING A TEMPLATE FOR SPECIALTY SHAPE WINDOWS

1. Tape butcher paper, Kraft or construction paper over the window opening allowing plenty of overlap.
2. Being careful not to press against the template paper while tracing, draw an exact outline of the window opening. Pressing on the template paper may distort the paper and cause the wrong size to be made.
3. Remove the paper from the window opening. If the blind is an outside mount, add the desired amount of overlap to the window outline and draw a second outline around it to match the shape of the finished blind. **Be sure to erase the inside line.**
4. Mark the dimensions on the template. Check that the template dimensions match your measurements of the actual window opening.  
**NOTE:** Make sure the template is of the window opening, not the glass only measurement.
5. **Cut the shape from the paper.**
6. **PLACE THE TEMPLATE BACK INTO THE WINDOW OPENING TO CHECK FOR PROPER FIT COMPLETELY AROUND.**
7. **Indicate on the template**
  - "room side" and "top" on the template
  - purchase order number
  - customer's name
  - your store name and account number
8. Roll up template and place in a mailing tube.  
**DO NOT FOLD TEMPLATE.**

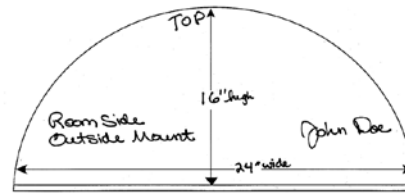

**NOTE:** This is just a sample for illustration purposes only—other information may be needed for your order.

**Mail to:** Springs Window Fashions LLC  
8467 Rt. 405 Hwy, South  
PO Box 500  
Montgomery PA 17752-0500  
ATTN: Specialty Dept.

**NOTE:** When mailing, make sure to get a tracking number and note your return address on the mailing tube.

### ACCEPTABLE MATERIALS FOR MAKING TEMPLATES:

Kraft Paper  
Butcher Paper  
Construction Paper

### WE WILL NOT ACCEPT TEMPLATES MADE FROM THE FOLLOWING MATERIALS:

Newspaper	Plastic
Wax Paper	Fabric
Tissue Paper	Roofing Paper
Existing Arch Blinds	Wrapping Paper

**NOTE:** If the material used to make a template stretches, tears easily, will not lay flat or will mark the fabric – IT WILL NOT BE USED.

## USING THE TEMPLATE SERVICE

To use the template service, simply:

1. Select Template Service when entering your order online.
2. Use the template worksheet to determine what measurements you need to supply for each shape.
3. Enter the lettered measurements using line item comments. The comments have been pre-programmed to all of the measurements you need to enter for your special shape.

See note at bottom of price grids if Template Service Fees apply.

## General Information

ALUMINUM COLOR ASSORTMENT							
Color Name	Color #	1" Insignia®	1" Classics	1" Cordless	1" Supreme	½" Micro Supreme	2" Grandeur™
Alabaster	112	✓	✓	✓	✓	✓	✓
Alabaster Pearl	326		✓	✓	✓	✓	✓
Almond	724		✓		✓		✓
Almost White Gloss	065	✓	✓	✓	✓	✓	✓
Aluminum	034	✓	✓	✓	✓	✓	
Ash Metallic	126		✓		✓		✓
Beige	011	✓	✓	✓	✓	✓	
Beige Pearl	328		✓	✓	✓		
Birch White	375		✓		✓		
Black Satin	233	✓	✓	✓	✓	✓	✓
Brushed Aluminum	121	✓	✓	✓	✓	✓	✓
Buff	624	✓	✓		✓		
Burgundy	653	✓	✓	✓	✓		
Cameo	607	✓	✓	✓	✓		
Canary Yellow	009			✓	✓		
Char Brown	062	✓	✓	✓	✓	✓	✓
Coconut	630	✓	✓	✓	✓		
Creamy Beige	670	✓	✓		✓	✓	✓
Crystal White	629	✓	✓	✓	✓	✓	
Desert Sand	625	✓	✓	✓	✓		
Fawn	031	✓	✓	✓	✓	✓	
Fawn Pearl	327		✓	✓	✓	✓	
Flax	541	✓	✓	✓	✓	✓	
Forest Shadow	087	✓	✓		✓		
Granite	044	✓	✓		✓		
Gray Dawn	405		✓		✓		
Gray Haze	983	✓	✓		✓	✓	✓
Greige	122	✓	✓		✓	✓	✓
Hunter Green	154		✓	✓	✓		✓
Ice	778	✓	✓		✓		
Lamplight	904	✓	✓	✓	✓		✓
Lavender Lace	024			✓	✓		
Little Boy Blue	090			✓	✓		
Magnet	648		✓		✓		
Matte White	042	✓	✓		✓	✓	
Mercury	771		✓		✓		
Midnight Blue	057		✓		✓		
Milk Chocolate	060	✓	✓	✓	✓	✓	
Navajo White	376		✓		✓		
Parchment	535	✓	✓		✓	✓	
Pitch Black	033	✓	✓		✓	✓	
Polished Aluminum	741	✓	✓	✓	✓		✓
Princess Pink	023			✓	✓		
Raw Umber	006	✓	✓		✓	✓	✓
Real Red	085	✓	✓	✓	✓		
Rock Gray	399		✓		✓		
Silver	737	✓	✓		✓		
Skyline	680		✓		✓		
Smokey Gray	026	✓	✓		✓	✓	
Snowcap White	386	✓	✓	✓	✓		✓
Stucco	963	✓	✓		✓		✓
Tender Taupe	103		✓		✓		
True Blue	089	✓	✓	✓	✓		
True White	544	✓	✓	✓	✓	✓	✓
U.N. Gray	095	✓	✓		✓		
Vanilla	100	✓	✓	✓	✓	✓	
White Gloss	005	✓	✓		✓	✓	✓
White Pearl	637		✓	✓	✓		
White Satin	205	✓	✓		✓	✓	✓

## General Information

## COLOR COORDINATION CHARTS: ½" &amp; 1" ALUMINUM

Color No.	Color Name	Rail & Brackets	Ladders & Cord	Tassels & Endcaps
005	White Gloss	005	005	005
006	Raw Umber	006	033	006
009	Canary Yellow	009	009	009
011	Beige	011	103	011
023	Princess Pink	023	023	023
024	Lavender Lace	024	024	024
026	Smokey Gray	026	026	026
031	Fawn	031	031	031
033	Pitch Black	033	033	033
034	Aluminum	034	026	026
042	Matte White	042	112	112
044	Granite	044	814	825
057	Midnight Blue	057	008	008
060	Milk Chocolate	060	060	060
062	Char Brown	062	062	062
065	Almost White Gloss	065	112	112
085	Real Red	085	835	025
087	Forest Shadow	087	087	087
089	True Blue	089	089	089
090	Little Boy Blue	090	090	090
095	U.N. Gray	095	033	591
100	Vanilla	100	112	100
103	Tender Taupe	103	103	103
112	Alabaster	112	112	112
121	Brushed Aluminum	034	026	026
122	Greige	122	026	122
126	Ash Metallic	126	126	126
154	Hunter Green	154	154	117
205	White Satin	205	005	005
233	Black Satin	233	033	033
326	Alabaster Pearl	112	112	112
327	Fawn Pearl	031	031	031
328	Beige Pearl	011	103	011
375	Birch White	375	005	005
376	Navajo White	376	112	112
386	Snowcap White	386	005	005
399	Rock Gray	399	026	026
405	Gray Dawn	405	026	026
535	Parchment	535	004	004
541	Flax	541	112	112
544	True White	544	005	005
607	Cameo	670	031	356
624	Buff	624	031	031
625	Desert Sand	625	029	029
629	Crystal White	629	005	005
630	Coconut	630	112	112
637	White Pearl	205	005	005
648	Magnet	648	648	648
653	Burgundy	653	106	106
670	Creamy Beige	670	031	356
680	Skyline	680	591	591
724	Almond	724	004	004
737	Silver	737	026	114
741	Polished Aluminum	034	026	026
771	Mercury	771	026	026
778	Ice	778	778	778
904	Lamplight	904	031	031
963	Stucco	963	026	963
983	Gray Haze	983	026	026

# General Information

## COLOR COORDINATION CHARTS: 2" GRANDEUR™ ALUMINUM

Color No.	Color Name	Rail & Brackets	Ladders & Cord	Tilts, Supports, Headrail End Caps	Tassels, Bottom Rail End Caps
005	White Gloss	205	005	White	005
006	Raw Umber	033	033	Black	006
062	Char Brown	062	062	Black	062
065	Almost White Gloss	112	112	White	112
112	Alabaster	112	112	White	112
121	Brushed Aluminum	034	026	Black	026
122	Greige	122	026	Black	122
126	Ash Metallic	126	126	Black	126
154	Hunter Green	154	154	Black	117
205	White Satin	205	005	White	005
233	Black Satin	233	033	Black	033
326	Alabaster Pearl	112	112	White	112
386	Snowcap White	386	005	White	005
544	True White	205	005	White	005
670	Creamy Beige	670	031	White	356
724	Almond	724	004	White	004
741	Polished Aluminum	034	026	Black	026
904	Lamplight	904	031	White	031
963	Stucco	963	026	White	963
983	Gray Haze	983	026	White	026

## LADDER COLOR COORDINATION: SKYLIGHT BLINDS, DUAL HEADRAIL AND INCLINE WIRE

The Graber® Skylight blind uses a specially constructed ladder designed for the interlacing of slats. The five ladder colors offered will coordinate with many slat colors.

**Note:** You may request a different ladder color.

Interlacing Ladder Color	Slat Color Examples					
<b>Char Brown #062</b>	Char Brown	062	Milk Chocolate	060	Tender Taupe	103
	Granite	044	Raw Umber	006		
<b>Smokey Gray #026</b>	Aluminum	034	Greige	122	Skyline	680
	Black Satin	233	Pitch Black	033	Smokey Gray	026
	Brushed Aluminum	121	Polished Aluminum	741	Stucco	963
	Gray Dawn	405	Rock Gray	399	UN Gray	095
	Gray Haze	983	Silver	737		
<b>Fawn #031</b>	Buff	624	Desert Sand	625	Lamplight	904
	Cameo	607	Fawn	031		
	Creamy Beige	670	Fawn Pearl	327		
<b>White Gloss #005</b>	Burgundy	653	Magnet	648	True Blue	089
	Coconut	630	Mercury	771	True White	544
	Crystal White	629	Midnight Blue	057	White Gloss	005
	Forest Shadow	087	Navajo White	376	White Satin	205
	Hunter Green	154	Real Red	085	White Pearl	637
	Ice	778	Snowcap White	386		
<b>Alabaster #112</b>	Alabaster	112	Ash Metallic	126	Flax	541
	Alabaster Pearl	326	Beige	011	Matte White	042
	Almond	724	Beige Pearl	328	Parchment	535
	Almost White Gloss	065	Birch White	375	Vanilla	100

## General Information

## STACK HEIGHT CHART

Finished Blind Height	Cordless Supreme	Cordless Supreme Hidden holes	Classics and Supreme	Supreme Hidden holes	Insignia®	Supreme ½" Micro	2" Grandeur™
10"			2"	2"	1 <sup>3</sup> / <sub>16</sub> "	2 <sup>1</sup> / <sub>16</sub> "	3 <sup>3</sup> / <sub>8</sub> "
15"	2 <sup>3</sup> / <sub>16</sub> "	2 <sup>1</sup> / <sub>8</sub> "	2 <sup>1</sup> / <sub>16</sub> "	2 <sup>1</sup> / <sub>8</sub> "	1 <sup>7</sup> / <sub>8</sub> "	2 <sup>1</sup> / <sub>4</sub> "	3 <sup>1</sup> / <sub>2</sub> "
20"	2 <sup>1</sup> / <sub>4</sub> "	2 <sup>1</sup> / <sub>4</sub> "	2 <sup>3</sup> / <sub>16</sub> "	2 <sup>1</sup> / <sub>4</sub> "	2"	2 <sup>7</sup> / <sub>16</sub> "	3 <sup>5</sup> / <sub>8</sub> "
25"	2 <sup>3</sup> / <sub>8</sub> "	2 <sup>3</sup> / <sub>8</sub> "	2 <sup>1</sup> / <sub>4</sub> "	2 <sup>3</sup> / <sub>8</sub> "	2 <sup>1</sup> / <sub>8</sub> "	2 <sup>11</sup> / <sub>16</sub> "	3 <sup>11</sup> / <sub>16</sub> "
30"	2 <sup>7</sup> / <sub>16</sub> "	2 <sup>1</sup> / <sub>2</sub> "	2 <sup>3</sup> / <sub>8</sub> "	2 <sup>1</sup> / <sub>2</sub> "	2 <sup>3</sup> / <sub>16</sub> "	2 <sup>7</sup> / <sub>8</sub> "	3 <sup>13</sup> / <sub>16</sub> "
35"	2 <sup>7</sup> / <sub>16</sub> "	2 <sup>7</sup> / <sub>16</sub> "	2 <sup>1</sup> / <sub>2</sub> "	2 <sup>11</sup> / <sub>16</sub> "	2 <sup>5</sup> / <sub>16</sub> "	3 <sup>3</sup> / <sub>8</sub> "	3 <sup>15</sup> / <sub>16</sub> "
40"	2 <sup>11</sup> / <sub>16</sub> "	2 <sup>7</sup> / <sub>16</sub> "	2 <sup>5</sup> / <sub>8</sub> "	2 <sup>13</sup> / <sub>16</sub> "	2 <sup>3</sup> / <sub>8</sub> "	3 <sup>1</sup> / <sub>4</sub> "	4 <sup>1</sup> / <sub>16</sub> "
45"	2 <sup>3</sup> / <sub>4</sub> "	2 <sup>3</sup> / <sub>4</sub> "	2 <sup>3</sup> / <sub>4</sub> "	2 <sup>15</sup> / <sub>16</sub> "	2 <sup>1</sup> / <sub>2</sub> "	3 <sup>7</sup> / <sub>16</sub> "	4 <sup>3</sup> / <sub>16</sub> "
50"	2 <sup>7</sup> / <sub>8</sub> "	2 <sup>7</sup> / <sub>8</sub> "	2 <sup>7</sup> / <sub>8</sub> "	3 <sup>1</sup> / <sub>16</sub> "	2 <sup>5</sup> / <sub>8</sub> "	3 <sup>11</sup> / <sub>16</sub> "	4 <sup>5</sup> / <sub>16</sub> "
55"	3"	3"	3"	3 <sup>1</sup> / <sub>4</sub> "	2 <sup>11</sup> / <sub>16</sub> "	3 <sup>7</sup> / <sub>8</sub> "	4 <sup>3</sup> / <sub>8</sub> "
60"	3 <sup>1</sup> / <sub>16</sub> "	3 <sup>1</sup> / <sub>16</sub> "	3 <sup>1</sup> / <sub>8</sub> "	3 <sup>3</sup> / <sub>8</sub> "	2 <sup>13</sup> / <sub>16</sub> "	4 <sup>1</sup> / <sub>16</sub> "	4 <sup>1</sup> / <sub>2</sub> "
65"	3 <sup>3</sup> / <sub>16</sub> "	3 <sup>3</sup> / <sub>16</sub> "	3 <sup>1</sup> / <sub>4</sub> "	3 <sup>1</sup> / <sub>2</sub> "	2 <sup>7</sup> / <sub>8</sub> "	4 <sup>7</sup> / <sub>16</sub> "	4 <sup>5</sup> / <sub>8</sub> "
70"	3 <sup>1</sup> / <sub>4</sub> "	3 <sup>1</sup> / <sub>4</sub> "	3 <sup>3</sup> / <sub>8</sub> "	3 <sup>11</sup> / <sub>16</sub> "	3"	4 <sup>1</sup> / <sub>2</sub> "	4 <sup>3</sup> / <sub>4</sub> "
75"	3 <sup>3</sup> / <sub>8</sub> "		3 <sup>7</sup> / <sub>16</sub> "	3 <sup>13</sup> / <sub>16</sub> "	3 <sup>1</sup> / <sub>8</sub> "	4 <sup>11</sup> / <sub>16</sub> "	4 <sup>7</sup> / <sub>8</sub> "
80"	3 <sup>1</sup> / <sub>2</sub> "		3 <sup>3</sup> / <sub>16</sub> "	3 <sup>15</sup> / <sub>16</sub> "	3 <sup>3</sup> / <sub>16</sub> "	4 <sup>7</sup> / <sub>8</sub> "	5"
85"			3 <sup>11</sup> / <sub>16</sub> "	4 <sup>1</sup> / <sub>16</sub> "	3 <sup>5</sup> / <sub>16</sub> "	5 <sup>1</sup> / <sub>8</sub> "	5 <sup>1</sup> / <sub>8</sub> "
90"			3 <sup>13</sup> / <sub>16</sub> "	4 <sup>1</sup> / <sub>4</sub> "	3 <sup>3</sup> / <sub>8</sub> "	5 <sup>5</sup> / <sub>16</sub> "	5 <sup>1</sup> / <sub>4</sub> "
95"			3 <sup>15</sup> / <sub>16</sub> "	4 <sup>3</sup> / <sub>8</sub> "	3 <sup>1</sup> / <sub>2</sub> "	5 <sup>1</sup> / <sub>2</sub> "	5 <sup>3</sup> / <sub>16</sub> "
100"			4 <sup>1</sup> / <sub>16</sub> "	4 <sup>1</sup> / <sub>2</sub> "	3 <sup>5</sup> / <sub>8</sub> "	5 <sup>11</sup> / <sub>16</sub> "	5 <sup>1</sup> / <sub>16</sub> "
105"			4 <sup>3</sup> / <sub>16</sub> "	4 <sup>5</sup> / <sub>8</sub> "	3 <sup>11</sup> / <sub>16</sub> "	5 <sup>7</sup> / <sub>8</sub> "	5 <sup>9</sup> / <sub>16</sub> "
110"			4 <sup>5</sup> / <sub>16</sub> "	4 <sup>13</sup> / <sub>16</sub> "	3 <sup>13</sup> / <sub>16</sub> "	6 <sup>1</sup> / <sub>8</sub> "	5 <sup>11</sup> / <sub>16</sub> "
115"			4 <sup>3</sup> / <sub>8</sub> "	4 <sup>15</sup> / <sub>16</sub> "	3 <sup>3</sup> / <sub>8</sub> "	6 <sup>5</sup> / <sub>16</sub> "	5 <sup>13</sup> / <sub>16</sub> "
120"			4 <sup>1</sup> / <sub>2</sub> "	5 <sup>1</sup> / <sub>16</sub> "	4"	6 <sup>1</sup> / <sub>2</sub> "	5 <sup>7</sup> / <sub>8</sub> "
125"			4 <sup>5</sup> / <sub>8</sub> "	5 <sup>3</sup> / <sub>16</sub> "	4 <sup>1</sup> / <sub>8</sub> "		6"

NOTE: Estimated finished blind heights include headrail and bottomrail.

# General Information

## SLAT COUNT CHART

Finished Blind Height	Cordless Supreme	Cordless Supreme Hidden holes	Supreme	Supreme Hidden holes	Supreme 1/2" Micro	2" Grandeur™	Insignia®	Classics
10			12	14	19	6	11	11
11			13	15	21	7	12	13
12	13	15	14	16	23	7	13	14
13	14	16	15	18	25	8	15	15
14	16	18	16	19	27	9	16	16
15	17	19	18	21	29	9	17	17
16	18	21	19	22	31	10	18	18
17	19	22	20	23	33	10	19	19
18	20	24	21	25	35	11	20	20
19	22	25	22	26	37	11	22	22
20	23	26	24	28	39	12	23	23
21	24	28	25	29	41	13	24	24
22	25	29	26	30	43	13	25	25
23	26	31	27	32	45	14	26	26
24	27	32	28	33	47	14	28	27
25	29	33	29	35	49	15	29	28
26	30	35	31	36	51	15	30	29
27	31	36	32	37	53	16	31	31
28	32	38	33	39	55	17	32	32
29	33	39	34	40	57	17	33	33
30	35	40	35	42	59	18	35	34
31	36	42	37	43	61	18	36	35
32	37	43	38	45	63	19	37	36
33	38	45	39	46	65	20	38	37
34	39	46	40	47	67	20	39	38
35	40	47	41	49	69	21	41	40
36	42	49	42	50	71	21	42	41
37	43	50	44	52	73	22	43	42
38	44	52	45	53	75	22	44	43
39	45	53	46	54	77	23	45	44
40	46	55	47	56	80	24	46	45
41	47	56	48	57	82	24	48	46
42	49	57	50	59	84	25	49	48
43	50	59	51	60	86	25	50	49
44	51	60	52	61	88	26	51	50
45	52	62	53	63	90	26	52	51
46	53	63	54	64	92	27	54	52
47	55	64	55	66	94	28	55	53
48	56	66	57	67	96	28	56	54
49	57	67	58	69	98	29	57	55
50	58	69	59	70	100	29	58	57
51	59	70	60	71	102	30	59	58
52	60	71	61	73	104	31	61	59
53	62	73	63	74	106	31	62	60
54	63	74	64	76	108	32	63	61
55	64	76	65	77	110	32	64	62
56	65	77	66	78	112	33	65	63
57	66	79	67	80	114	33	67	64
58	68	80	68	81	116	34	68	66
59	69	81	70	83	118	35	69	67
60	70	83	71	84	120	35	70	68
61	71	84	72	85	122	36	71	69
62	72	86	73	87	124	36	72	70
63	73	87	74	88	126	37	74	71
64	75	88	76	90	128	37	75	72
65	76	90	77	91	130	38	76	73
66	77	91	78	93	132	39	77	75
67	78	93	79	94	134	39	78	76
68	79	94	80	95	136	40	79	77
69	81	95	81	97	138	40	81	78
70	82	97	83	98	140	41	82	79
71	83	98	84	100	143	41	83	80
72	84	100	85	101	145	42	84	81
73	85		86	102	147	43	85	83
74	86		87	104	149	43	87	84
75	88		89	105	151	44	88	85
76	89		90	107	153	44	89	86
77	90		91	108	155	45	90	87
78	91		92	109	157	46	91	88
79	92		93	111	159	46	92	89
80	94		94	112	161	47	94	90
81	95							92
82	96							93
83	97							94
84	98							95
85								96
86								97
87								98
88								99
89								101
90								102
91								103
92								104
93								105
94								106
95								107
96								108
97								110
98								111
99								112
100								113
101								114
102								115
103								116
104								117
105								119
106								120
107								121
108								122
109								123
110								124
111								125
112								127
113								128
114								129
115								130
116								131
117								132
118								133
119								134
120								136
121								137
122								138
123								140
124								141
125								142
126								143
127								144
128								145
129								146
130								147
131								148
132								149
133								150
134								151
135								152
136								153
137								154
138								155
139								156
140								157
141								158
142								159
143								160
144								161
145								162
146								163
147								164
148								165
149								166
150								167
								168
								169
								170
								171
								172
								173
								174
								175
								176
								177

# General Information

## SLAT ROUT AND LADDER COUNT

### CORDLESS SUPREME

#### For Standard or Reverse Controls

Finished Blind Width	Slat End Route	# of Ladders	# of Lifts	# of Center Brackets
16 to 17 <sup>1</sup> / <sub>16</sub> "	5 <sup>1</sup> / <sub>2</sub> "	2	2	2
18 to 20 <sup>1</sup> / <sub>16</sub> "	6"	2	2	2
21 to 37"	6 <sup>1</sup> / <sub>2</sub> "	2	2	2
37 to 61"	6 <sup>1</sup> / <sub>2</sub> "	3	2	2, Over 42" use 3
61 to 85"	6 <sup>1</sup> / <sub>2</sub> "	4	4	3, over 72" use 4
85 to 109"	6 <sup>1</sup> / <sub>2</sub> "	5	4	4, over 102" use 5

- Notes:** 1. Maximum spacing between ladders is 24".  
2. Standard control positions: Tilt left.

### SUPREME

#### Standard and Hidden holes Option

Finished Blind Width	Slat End Route	# of Ladders	# of Lifts	# of Brackets
5 <sup>1</sup> / <sub>2</sub> to 6 <sup>1</sup> / <sub>16</sub> "	1 <sup>1</sup> / <sub>2</sub> "	2	2	2
7 to 8 <sup>1</sup> / <sub>16</sub> "	2"	2	2	2
9 to 11 <sup>1</sup> / <sub>16</sub> "	3"	2	2	2
12 to 20 <sup>1</sup> / <sub>16</sub> "	4"	2	2	2
21 to 37"	6 <sup>1</sup> / <sub>2</sub> "	2	2	2
37 <sup>1</sup> / <sub>16</sub> to 61"	6 <sup>1</sup> / <sub>2</sub> "	3	2	2 3 over 60" FBW
61 <sup>1</sup> / <sub>16</sub> to 85"	6 <sup>1</sup> / <sub>2</sub> "	4	4	3 4 over 96" FBW
85 <sup>1</sup> / <sub>16</sub> to 109"	6 <sup>1</sup> / <sub>2</sub> "	5	4	4
109 <sup>1</sup> / <sub>16</sub> to 133"	6 <sup>1</sup> / <sub>2</sub> "	6	4	4
133 <sup>1</sup> / <sub>16</sub> to 142"	6 <sup>1</sup> / <sub>2</sub> "	7	4	4

#### For Same Side Controls

11 <sup>1</sup> / <sub>16</sub> to 20 <sup>1</sup> / <sub>16</sub> "	4"	As Above	As Above	As Above
21 to 142"	6 <sup>1</sup> / <sub>2</sub> "	As Above	As Above	As Above

- Notes:** 1. Maximum spacing between ladders is 24".  
2. Standard control positions: Lift right/Tilt left.  
3. Maximum slat width is 142". Wider blinds must be multiple stack.

### SUPREME WITH SIDE MOUNT BRACKETS

#### For Standard or Reverse Controls

Finished Blind Width	Slat End Route	# of Ladders	# of Lifts
7 <sup>1</sup> / <sub>2</sub> to 8 <sup>1</sup> / <sub>16</sub> "	2"	2	2
9 to 11 <sup>1</sup> / <sub>16</sub> "	3"	2	2
12 to 20 <sup>1</sup> / <sub>16</sub> "	4"	2	2
21 to 37"	6 <sup>1</sup> / <sub>2</sub> "	2	2
37 <sup>1</sup> / <sub>16</sub> to 60"	6 <sup>1</sup> / <sub>2</sub> "	3	2

#### For Same Side Controls

12 to 20 <sup>1</sup> / <sub>16</sub> "	4"	As Above	As Above
21 to 60"	6 <sup>1</sup> / <sub>2</sub> "	As Above	As Above

- Notes:** 1. Maximum spacing between ladders is 24".  
2. Standard control positions: Lift right/Tilt left.  
3. Maximum spacing for using side mount brackets is 60"

### CLASSICS

#### For Standard or Reverse Controls

Finished Blind Width	Slat End Route	# of Ladders	# of Lifts	# of Center Brackets
5 <sup>1</sup> / <sub>2</sub> to 6 <sup>1</sup> / <sub>16</sub> "	1 <sup>1</sup> / <sub>16</sub> "	2	2	0
7 to 8 <sup>1</sup> / <sub>16</sub> "	2"	2	2	0
9 to 11 <sup>1</sup> / <sub>16</sub> "	3 <sup>1</sup> / <sub>4</sub> "	2	2	0
12 to 20 <sup>1</sup> / <sub>16</sub> "	4"	2	2	0
21 to 37"	6 <sup>1</sup> / <sub>2</sub> "	2	2	0
37 <sup>1</sup> / <sub>16</sub> to 61"	6 <sup>1</sup> / <sub>2</sub> "	3	2	1 over 60" FBW
61 <sup>1</sup> / <sub>16</sub> to 85"	6 <sup>1</sup> / <sub>2</sub> "	4	4	1
85 <sup>1</sup> / <sub>16</sub> to 109"	6 <sup>1</sup> / <sub>2</sub> "	5	4	2 over 96" FBW
109 <sup>1</sup> / <sub>16</sub> to 133"	6 <sup>1</sup> / <sub>2</sub> "	6	4	2
133 <sup>1</sup> / <sub>16</sub> to 143 <sup>3</sup> / <sub>4</sub> "	6 <sup>1</sup> / <sub>2</sub> "	7	4	2

#### For Same Side Controls

13 <sup>1</sup> / <sub>16</sub> to 20 <sup>1</sup> / <sub>16</sub> "	4 <sup>7</sup> / <sub>8</sub> "	2	2	0
21 to 143 <sup>3</sup> / <sub>4</sub> "	6 <sup>1</sup> / <sub>2</sub> "	See above for # of Ladders, Lifts and Brackets		

- Notes:** 1. Maximum spacing between ladders is 24".  
2. Standard control positions: Lift right/ Tilt left.



# General Information

## SLAT ROUT AND LADDER COUNT

### INSIGNIA™

#### For Standard or Reverse Controls

Finished Blind Width	Slat End Route	# of Ladders	# of Lifts	# of Center Brackets
5½ to 8½ <sup>1</sup> / <sub>16</sub> "	1½"	2	2	0
9 to 11½ <sup>1</sup> / <sub>16</sub> "	3"	2	2	0
12 to 20½ <sup>1</sup> / <sub>16</sub> "	4"	2	2	0
21 to 37"	6½"	2	2	0
37½ <sup>1</sup> / <sub>16</sub> to 61"	6½"	3	2	1 over 48" FBW
61½ <sup>1</sup> / <sub>16</sub> to 85"	6½"	4	4	1
85½ <sup>1</sup> / <sub>16</sub> to 109"	6½"	5	4	2 over 96" FBW
109½ <sup>1</sup> / <sub>16</sub> to 120"	6½"	6	4	2

#### For Same Side Controls

Finished Blind Width	Slat End Route	# of Ladders	# of Lifts	# of Center Brackets
11½ <sup>1</sup> / <sub>16</sub> to 20½ <sup>1</sup> / <sub>16</sub> "	4"	As Above	As Above	As Above
21 to 120"	6½"	As Above	As Above	As Above

- Notes:** 1. Maximum spacing between ladders is 24".  
2. Standard control positions: Lift right/Tilt left.

### MICRO SUPREME

#### For Standard or Reverse Controls

Finished Blind Width	Slat End Route	# of Ladders	# of Lifts	# of Center Brackets
5½ to 6½ <sup>1</sup> / <sub>16</sub> "	1½"	2	2	2
7 to 8½ <sup>1</sup> / <sub>16</sub> "	2"	2	2	2
9 to 11½ <sup>1</sup> / <sub>16</sub> "	3"	2	2	2
12 to 22"	4"	2	2	2
22½ <sup>1</sup> / <sub>16</sub> to 36"	4"	3	2	2
36½ <sup>1</sup> / <sub>16</sub> to 50"	4"	4	2	2
50½ <sup>1</sup> / <sub>16</sub> to 64"	4"	5	4	3 over 60" FBW
64½ <sup>1</sup> / <sub>16</sub> to 78"	4"	6	4	3
78½ <sup>1</sup> / <sub>16</sub> to 92"	4"	7	4	4
92½ <sup>1</sup> / <sub>16</sub> to 106"	4"	8	4	4
106½ <sup>1</sup> / <sub>16</sub> to 120"	4"	9	4	4

#### For Same Side Controls

Finished Blind Width	Slat End Route	# of Ladders	# of Lifts	# of Center Brackets
12 to 120"	4"	As Above	As Above	As Above

- Notes:** 1. Maximum spacing between ladders is 14".  
2. Standard Blinds: Standard control positions: Lift right/Tilt left.

### MICRO SUPREME WITH SIDE MOUNT BRACKETS

#### For Standard or Reverse Controls

Finished Blind Width	Slat End Route	# of Ladders	# of Lifts
7½ to 8½ <sup>1</sup> / <sub>16</sub> "	2"	2	2
9 to 11½ <sup>1</sup> / <sub>16</sub> "	3"	2	2
12 to 22"	4"	2	2
22½ <sup>1</sup> / <sub>16</sub> to 36"	4"	3	2
36½ <sup>1</sup> / <sub>16</sub> to 50"	4"	4	2
50½ <sup>1</sup> / <sub>16</sub> to 60"	4"	5	4

#### For Same Side Controls

Finished Blind Width	Slat End Route	# of Ladders	# of Lifts
12 to 22"	4"	2	2
22½ <sup>1</sup> / <sub>16</sub> to 36"	4"	3	2
36½ <sup>1</sup> / <sub>16</sub> to 50"	4"	4	2
50½ <sup>1</sup> / <sub>16</sub> to 60"	4"	5	4

- Notes:** 1. Maximum spacing between ladders is 14".  
2. Standard control positions: Lift right/Tilt left.  
3. Maximum FBW for side mount brackets is 60"

### GRANDEUR™ 2" ALUMINUM

#### For Standard or Reverse Controls

Finished Blind Width	Slat End Route	# of Ladders	# of Lifts	# of Center Brackets
9 to 10" on cord tilt only	2¾"	2	2	0
9 to 11½ <sup>1</sup> / <sub>16</sub> "	2¾"	2	2	0
12 to 24"	4"	2	2	0
24½ <sup>1</sup> / <sub>16</sub> to 36"	6"	2	2	0
36½ <sup>1</sup> / <sub>16</sub> to 60"	6"	3	2	1 over 48" FBW
60½ <sup>1</sup> / <sub>16</sub> to 84"	6"	4	4	2 over 72" FBW
84½ <sup>1</sup> / <sub>16</sub> to 108"	6"	5	4	2
108½ <sup>1</sup> / <sub>16</sub> to 132"	6"	6	4	3
132½ <sup>1</sup> / <sub>16</sub> to 142"	6"	7	4	4

#### For Same Side Controls

Finished Blind Width	Slat End Route	# of Ladders	# of Lifts	# of Center Brackets
16½ <sup>1</sup> / <sub>16</sub> to 36"	6"	2	2	0
36½ <sup>1</sup> / <sub>16</sub> to 60"	6"	3	2	1 over 48" FBW
60½ <sup>1</sup> / <sub>16</sub> to 84"	6"	4	4	2 over 72" FBW
84½ <sup>1</sup> / <sub>16</sub> to 108"	6"	5	4	2
108½ <sup>1</sup> / <sub>16</sub> to 132"	6"	6	4	3
132½ <sup>1</sup> / <sub>16</sub> to 142"	6"	7	4	4

- Notes:** 1. Maximum spacing between ladders is 24".  
2. Standard control positions: Lift right/Tilt left.  
3. Maximum headrail width for multiple stack blinds is 142".  
Maximum slat width is 142".

# General Information

## ½" MICRO SUPREME AND 1" SUPREME PRODUCT DETAIL

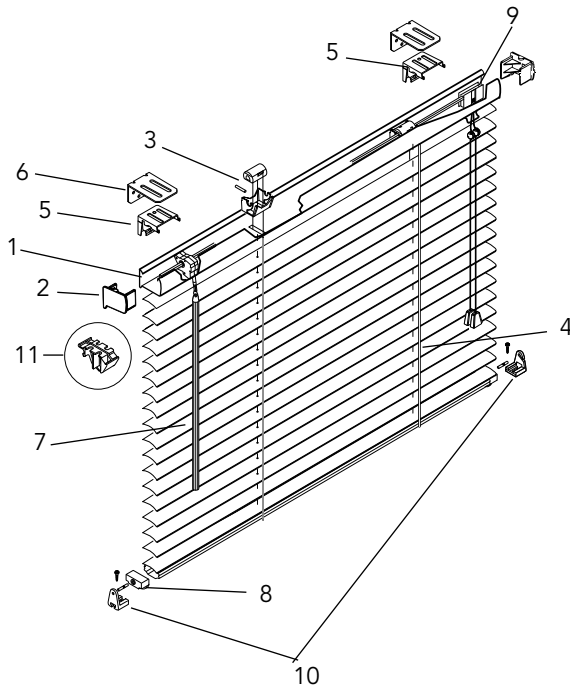

1. **No-valance Headrail**
  - Cleaner, smoother appearance
  - Light-blocking lip eliminates light gap between headrail and top slat
2. **Color-coordinated End Caps**
  - Provide a custom finished look
3. **Precision Rollers**
  - Require less effort to raise blinds
4. **Tighter Ladder Spacing**
  - More slats per foot for greater light-blocking ability
5. **Hidden Headrail Brackets**
  - Stable, easy to install, and reduce light gap
6. **Optional projection brackets**
  - Available in ⅜", 1¼", 2¾" and 4¾" sizes
7. **Clutch Wand Tilt**
  - Releases to prevent tilt damage
8. **Bottomrail Bumper Pads**
  - Provide cushioning and prevent blind from rattling and scratching window sill
  - Not available on Micro Supreme
9. **Crash-proof Cord Lock**
  - Prevents blind and/or sill damage
10. **Optional Hold-down Brackets**
  - Secure blind to wall, door or window sill
11. **Optional Side Mount Brackets**

# General Information

## 1" CORDLESS SUPREME ALUMINUM BLIND PRODUCT DETAIL

**Cordless blinds are the safest window blind alternative; ideal for homes with children and pets. Elimination of lift cords and cord loops provides a more attractive appearance.**

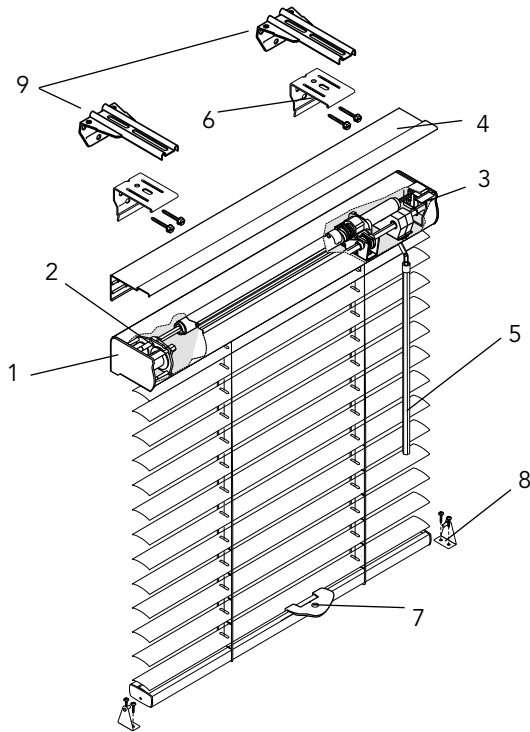

1. **Aluminum Headrail**
  - Sleek, color-coordinated for a modern look
  - No valance required
2. **Power Assembly**
  - Internal gear-driven motor for smooth, quiet operation and long lasting life
3. **Internal Cord Lift System**
  - Prevents cords from tangling or rolling on top of each other
4. **Dust Cover**
  - Reduces build-up of dust and debris which would otherwise slow down internal workings
5. **Clutch Wand Tilt**
  - Releases to prevent tilt damage
6. **Hidden Headrail Brackets**
  - Stable, easy to install; reduce light gap
7. **Handle**
  - Keeps the blind clean; a simple push or pull raises or lowers the blind
8. **Optional Bottomrail Hold-down Brackets**
  - Prevent bottomrail from rattling in windowsill or on door frame
9. **Projection Brackets**
  - Available in 2" or 3½" lengths

# General Information

## 1" CLASSICS ALUMINUM BLIND PRODUCT DETAIL

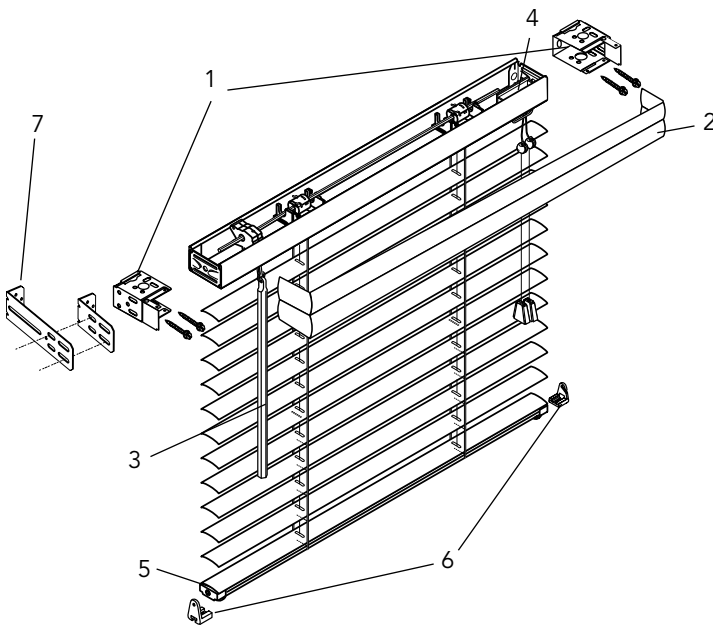

1. **Box Brackets**
  - Make it a snap to install
  - Deluxe two-slat valance provides a more attractive look
2. **Two-slat Valance**
  - Provides a more finished look
3. **Clutch Wand Tilt**
  - Automatically releases to prevent damage when over rotated
4. **Crash-proof Cordlock**
  - Prevent sill damage
5. **Bottomrail Bumper Pads**
  - Prevent sill damage
6. **Optional Hold-down Brackets**
  - Secures blind to wall, door or window sill
7. **Projection Brackets**
  - Available in short (1¾"), medium (2¾") or long (4¾") lengths

# General Information

## 1" INSIGNIA™ ALUMINUM BLIND PRODUCT DETAIL

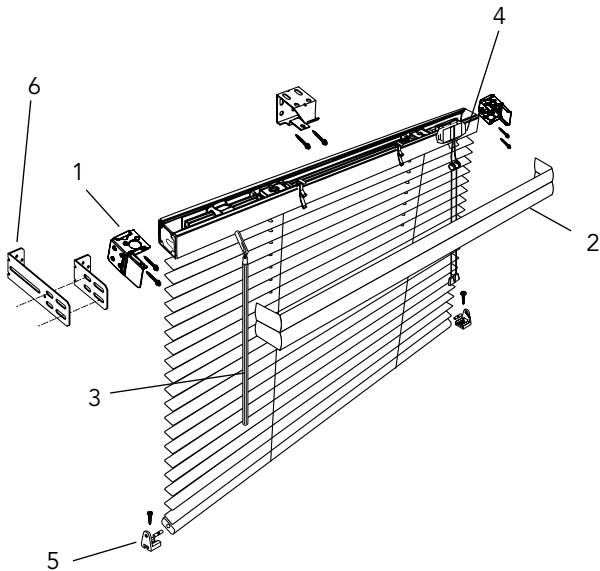

1. Box Brackets:
  - Make it a snap to install
2. Two-slat Valance
  - Provides a more finished look
3. Clutch Wand Tilt:
  - Automatically releases to prevent damage when over rotated
4. Crash-proof Cordlock
  - Prevents sill damage
5. Optional Hold-down Brackets
  - Secure blind to wall, door or window sill
6. Projection Brackets
  - Available in short (1¾"), medium (2¾") or long (4¾") lengths

## 2" GRANDEUR™ ALUMINUM BLIND PRODUCT DETAIL

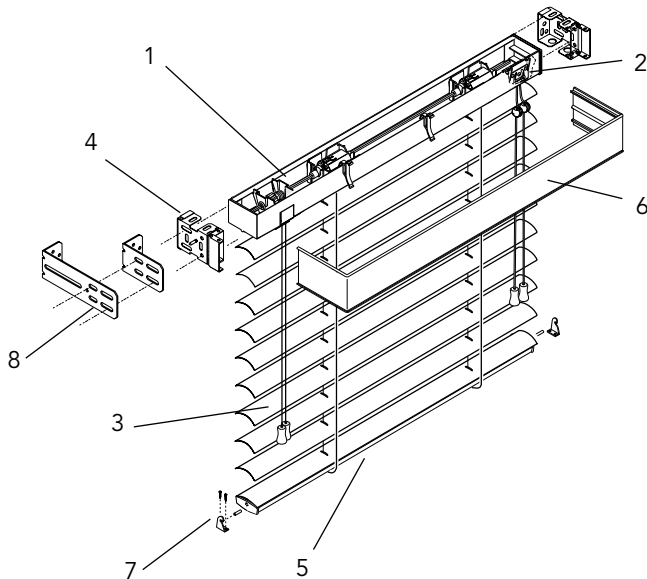

1. Patented SureClose™ Headrail
  - Provides tightest closure for superior privacy and light control
  - Light-blocking lip eliminates light gap between headrail and top slat
  - Lower profile is less obtrusive
2. Crash-proof Cordlock
  - Prevents blind and/or sill damage
3. Color-coordinated Cord Tilt
  - Precision engineered for durability; wand tilt also available
4. Mounting Brackets
  - Designed for easy installation
5. 8-gauge Dust-repellent Slats
  - Manufactured from heavy-duty aluminum
  - Harder surface is less porous and more stain and scratch resistant
6. Deluxe Channel Panel Valance
  - Provides a sleek, finished appearance
7. Optional Hold-down Brackets
  - Secure blind to wall, door or window sill
8. Projection Brackets
  - Available in medium (2¾") or long (4¾") lengths



# Price Charts: Aluminum Blinds

## PRICE GROUP A: 1" CORDLESS SUPREME MINI BLINDS

### 1" SLATS .006 GAUGE

HEIGHT UP TO ↓	WIDTH UP TO →																			
	23"	26"	29"	32"	36"	40"	44"	48"	52"	57"	62"	67"	72"	82"	92"	102"	112"	122"	132"	144"
42"	\$158	163	169	183	190	203	217	228	239	256	266	283	296	351	378	415	440	469	529	552
48"	161	168	181	190	202	213	227	240	252	272	284	300	314	371	405	437	464	499	559	588
54"	166	180	187	194	210	223	236	250	260	287	303	315	334	391	426	461	493	526	588	622
60"	177	186	191	209	220	231	248	260	275	301	315	334	348	410	444	488	521	555	619	653
66"	181	190	206	217	227	244	256	273	292	313	330	345	368	429	463	513	545	584	653	690
72"	186	198	211	221	239	252	269	290	303	328	345	364	388	449	490	536	575	617	683	721
78"	194	206	217	227	247	261	281	301	314	340	361	384	403	474						
84"	203	213	224	239	257	273	294	309	328	359	379	399	417							
<b>SURCHARGE: HIDDEN HOLES</b>																				
Hidden Holes Surcharge	8	8	8	9	11	12	12	13	13	16	16	17	19	23	24	28	29	32	35	36

Hidden holes only available in sizes above the heavy line.

**MAXIMUM SIZE: Cordless: 6400 sq. in.**  
**Cordless with Hidden Holes: 5900 sq. in.**

**Multiple Blinds on One Headrail**  
 Blinds less than 96":  
**Add surcharge:**  
 \$46 two on one headrail  
 \$64 three on one headrail

**Multiple Blinds on One Headrail**  
 Blind widths 96" to 144":  
**No charge**

### 1" SLATS .008 GAUGE

HEIGHT UP TO ↓	WIDTH UP TO →																			
	23"	26"	29"	32"	36"	40"	44"	48"	52"	57"	62"	67"	72"	82"	92"	102"	112"	122"	132"	144"
42"	\$165	169	177	193	200	213	231	242	252	270	282	300	314	371	402	440	468	499	562	584
48"	167	176	191	200	213	226	241	253	267	290	303	318	334	395	429	465	493	530	594	625
54"	174	190	197	204	223	237	249	265	275	305	322	336	356	414	454	492	525	561	626	663
60"	188	196	201	220	233	245	262	275	293	320	336	356	371	436	473	520	556	592	661	695
66"	191	200	217	230	242	258	271	291	309	334	353	368	394	457	495	549	582	627	697	737
72"	195	209	224	235	254	267	287	307	322	351	368	389	415	479	523	573	616	662	731	771
78"	204	219	230	242	262	277	299	320	335	363	386	411	429	507						
84"	214	225	239	254	273	293	313	329	352	384	406	425	449							
<b>SURCHARGE: HIDDEN HOLES</b>																				
Hidden Holes Surcharge	8	8	8	9	11	12	12	13	13	16	16	17	19	23	24	28	29	32	35	36

Hidden holes only available in sizes above the heavy line.

**MAXIMUM SIZE: Cordless: 6400 sq. in.**  
**Cordless with Hidden Holes: 5900 sq. in.**

**Multiple Blinds on One Headrail**  
 Blinds less than 96":  
**Add surcharge:**  
 \$46 two on one headrail  
 \$64 three on one headrail

**Multiple Blinds on One Headrail**  
 Blind widths 96" to 144":  
**No charge**

## COLORS

Alabaster . . . . .	112
Almost White Gloss . . . . .	065
Aluminum . . . . .	034
Beige . . . . .	011
Black Satin . . . . .	233
Burgundy . . . . .	653
Cameo . . . . .	607
Canary Yellow . . . . .	009
Char Brown . . . . .	062

Coconut . . . . .	630
Crystal White . . . . .	629
Desert Sand . . . . .	625
Fawn . . . . .	031
Flax . . . . .	541
Hunter Green . . . . .	154
Lamplight . . . . .	904
Lavender Lace . . . . .	024
Little Boy Blue . . . . .	090

Milk Chocolate . . . . .	060
Princess Pink . . . . .	023
Real Red . . . . .	085
Snowcap White . . . . .	386
True Blue . . . . .	089
True White . . . . .	544
Vanilla . . . . .	100

### PREMIUM COLORS (10% Surcharge)

Alabaster Pearl . . . . .	326
Beige Pearl . . . . .	328
Brushed Aluminum . . . . .	121
Fawn Pearl . . . . .	327
Polished Aluminum . . . . .	741
White Pearl . . . . .	637

# Price Charts: Aluminum Blinds

## PRICE GROUP B: 1" SUPREME MINI BLINDS

### 1" SLATS .006 GAUGE

HEIGHT UP TO	WIDTH UP TO →																Add'l 10"					
	12"	23"	26"	29"	32"	36"	40"	44"	48"	52"	57"	62"	67"	72"	82"	92"		102"	112"	122"	132"	142"
42"	\$88	72	75	82	91	98	108	118	125	134	149	157	170	179	203	223	255	274	299	323	340	24
48"	91	75	82	93	98	110	118	129	137	147	165	174	188	198	223	250	276	299	327	353	375	29
54"	97	82	93	98	102	118	129	137	147	155	179	194	203	217	243	271	301	327	356	381	410	30
60"	108	93	98	102	117	129	137	149	157	170	194	206	221	231	262	289	327	356	384	413	440	33
66"	111	96	102	117	125	137	149	157	170	187	206	221	232	252	282	308	353	379	414	447	477	34
72"	115	100	110	122	131	147	157	170	187	198	221	236	252	271	301	335	375	410	447	477	509	37
78"	123	108	118	129	137	155	166	183	198	209	232	252	271	287	326	356	402	434	474	509	542	38
84"	133	117	125	137	147	165	179	195	206	223	252	270	287	301	345	376	425	465	506	539	574	41
90"	138	122	134	145	155	174	194	203	221	232	262	282	299	323	361	402	447	489	531	572	612	44
96"	144	129	137	149	159	187	200	217	231	250	276	296	320	337	379	422	474	513	563	604	641	45
102"	149	134	147	157	170	194	209	225	243	260	293	311	335	356	402	445	499	542	590	634	680	48
108"	156	141	153	165	179	200	221	236	255	274	304	327	353	372	422	468	525	567	619	665	714	49
114"	162	147	157	174	188	209	227	250	270	287	323	345	369	391	440	489	547	592	652	710	770	54
120"	164	149	165	183	198	221	236	260	279	299	335	356	381	410	465	510	572	624	675	725	776	54
126"	170	155	174	194	203	227	252	271	289	308	349	375	402	425	481	531	596	649	700	752	801	56
<b>SURCHARGE: HIDDEN HOLES</b>																						
Hidden Holes Surcharge	8	8	8	8	9	11	12	12	13	13	16	16	17	19	23	24	28	29	32	35	36	3

**NOTE:** Smallest width available 5½" exact.  
Widths from 5½" to 8¹⁵⁄₁₆" are center tilt only.

**Multiple Blinds on One Headrail** Blinds less than 142":  
**Add surcharge: \$46 two on one headrail**  
**\$64 three on one headrail**  
Blind widths 142" to 192": **No charge**

### 1" SLATS .008 GAUGE

HEIGHT UP TO	WIDTH UP TO →																Add'l 10"					
	12"	23"	26"	29"	32"	36"	40"	44"	48"	52"	57"	62"	67"	72"	82"	92"		102"	112"	122"	132"	142"
42"	\$96	81	83	90	101	108	118	133	139	147	163	172	188	198	223	247	279	303	327	356	372	29
48"	98	83	90	102	108	121	133	142	150	162	183	194	206	217	247	274	305	327	360	388	413	32
54"	105	90	102	108	112	133	142	150	162	170	198	213	223	240	266	299	332	360	391	420	451	33
60"	117	102	108	112	129	142	150	163	172	188	213	226	244	255	289	318	360	391	421	455	482	36
66"	120	105	112	129	139	150	163	172	188	204	226	244	256	276	309	340	388	417	457	491	525	37
72"	124	109	121	137	143	162	172	188	204	217	244	259	276	299	332	368	413	451	491	525	559	41
78"	134	118	133	142	150	170	184	200	217	230	256	276	299	313	359	391	443	477	522	559	596	42
84"	144	129	139	150	162	183	198	214	226	247	276	297	313	332	379	414	468	511	556	594	631	45
90"	152	137	147	158	170	194	213	223	244	256	289	309	327	356	398	443	491	538	585	630	673	48
96"	157	142	150	163	174	204	219	240	255	274	305	324	353	371	417	465	522	564	619	664	706	49
102"	162	147	162	172	188	213	230	248	266	288	322	342	368	391	443	489	550	596	648	697	749	52
108"	169	154	168	183	198	219	244	259	279	303	335	360	388	410	465	514	578	624	680	732	785	54
114"	177	162	172	194	206	230	251	274	297	313	356	379	406	429	482	538	601	652	717	781	847	60
120"	179	163	183	200	217	244	259	288	308	327	368	391	420	451	511	560	630	687	742	798	853	60
126"	186	170	194	213	223	251	276	299	318	340	384	413	443	468	529	585	657	714	770	827	881	61
<b>SURCHARGE: HIDDEN HOLES</b>																						
Hidden Holes Surcharge	8	8	8	8	9	11	12	12	13	13	16	16	17	19	23	24	28	29	32	35	36	3

**NOTE:** Smallest width available 5½" exact.  
Widths from 5½" to 8¹⁵⁄₁₆" are center tilt only.

**Multiple Blinds on One Headrail** Blinds less than 142":  
**Add surcharge: \$46 two on one headrail**  
**\$64 three on one headrail**  
Blind widths 142" to 192": **No charge**

## COLORS

Alabaster . . . . . 112	Fawn . . . . . 031	Milk Chocolate . . . . . 060	U.N. Gray . . . . . 095
Almond . . . . . 724	Flax . . . . . 541	Navajo White . . . . . 376	Vanilla . . . . . 100
Almost White Gloss . . . 065	Forest Shadow . . . . . 087	Parchment . . . . . 535	White Gloss . . . . . 005
Aluminum . . . . . 034	Granite . . . . . 044	Pitch Black . . . . . 033	White Satin . . . . . 205
Beige . . . . . 011	Gray Dawn . . . . . 405	Princess Pink . . . . . 023	
Birch White . . . . . 375	Gray Haze . . . . . 983	Raw Umber . . . . . 006	
Black Satin . . . . . 233	Greige . . . . . 122	Real Red . . . . . 085	
Buff . . . . . 624	Hunter Green . . . . . 154	Rock Gray . . . . . 399	
Burgundy . . . . . 653	Ice . . . . . 778	Silver . . . . . 737	
Cameo . . . . . 607	Lamplight . . . . . 904	Skyline . . . . . 680	
Canary Yellow . . . . . 009	Lavender Lace . . . . . 024	Smokey Gray . . . . . 026	
Char Brown . . . . . 062	Little Boy Blue . . . . . 090	Snowcap White . . . . . 386	
Coconut . . . . . 630	Magnet . . . . . 648	Stucco . . . . . 963	
Creamy Beige . . . . . 670	Matte White . . . . . 042	Tender Taupe . . . . . 103	
Crystal White . . . . . 629	Mercury . . . . . 771	True Blue . . . . . 089	
Distal Sand . . . . . 625	Midnight Blue . . . . . 057	True White . . . . . 544	

### PREMIUM COLORS (10% Surcharge)

Alabaster Pearl . . . . . 326
Ash Metallic . . . . . 126
Beige Pearl . . . . . 328
Brushed Aluminum . . . . 121
Fawn Pearl . . . . . 327
Polished Aluminum . . . . 741
White Pearl . . . . . 637



# Price Charts: Aluminum Blinds

## PRICE GROUP C: 1" CLASSICS MINI BLINDS

### 1" SLATS .006 GAUGE

HEIGHT UP TO	WIDTH UP TO																	Add'l 10"				
	12"	23"	26"	29"	32"	36"	40"	44"	48"	52"	57"	62"	67"	72"	82"	92"	102"		112"	122"	132"	142"
42"	\$88	72	75	82	91	98	108	118	125	134	149	157	170	179	203	223	255	274	299	323	340	24
48"	91	75	82	93	98	110	118	129	137	147	165	174	188	198	223	250	276	299	327	353	375	29
54"	97	82	93	98	102	118	129	137	147	155	179	194	203	217	243	271	301	327	356	381	410	30
60"	108	93	98	102	117	129	137	149	157	170	194	206	221	231	262	289	327	356	384	413	440	33
66"	111	96	102	117	125	137	149	157	170	187	206	221	232	252	282	308	353	379	414	447	477	34
72"	115	100	110	122	131	147	157	170	187	198	221	236	252	271	301	335	375	410	447	477	509	37
78"	123	108	118	129	137	155	166	183	198	209	232	252	271	287	326	356	402	434	474	509	542	38
84"	133	117	125	137	147	165	179	195	206	223	252	270	287	301	345	376	425	465	506	539	574	41
90"	138	122	134	145	155	174	194	203	221	232	262	282	299	323	361	402	447	489	531	572	612	44
96"	144	129	137	149	159	187	200	217	231	250	276	296	320	337	379	422	474	513	563	604	641	45
102"	149	134	147	157	170	194	209	225	243	260	293	311	335	356	402	445	499	542	590	634	680	48
108"	156	141	153	165	179	200	221	236	255	274	304	327	353	372	422	468	525	567	619	665	714	49
114"	162	147	157	174	188	209	227	250	270	287	323	345	369	391	440	489	547	592	652	710	770	54
120"	164	149	165	183	198	221	236	260	279	299	335	356	381	410	465	510	572	624	675	725	776	54
126"	170	155	174	194	203	227	252	271	289	308	349	375	402	425	481	531	596	649	700	752	801	56

**NOTE:** Smallest width available 5½" exact.  
Widths from 5½" to 8½" are center tilt only.  
143¾" max. single blind.

**Multiple Blinds on One Headrail** Blinds less than 142":  
**Add surcharge: \$46 two on one headrail**  
**\$64 three on one headrail**  
Blind widths 142" to 192": **No charge**

### 1" SLATS .008 GAUGE

HEIGHT UP TO	WIDTH UP TO																	Add'l 10"				
	12"	23"	26"	29"	32"	36"	40"	44"	48"	52"	57"	62"	67"	72"	82"	92"	102"		112"	122"	132"	142"
42"	\$96	81	83	90	101	108	118	133	139	147	163	172	188	198	223	247	279	303	327	356	372	29
48"	98	83	90	102	108	121	133	142	150	162	183	194	206	217	247	274	305	327	360	388	413	32
54"	105	90	102	108	112	133	142	150	162	170	198	213	223	240	266	299	332	360	391	420	451	33
60"	117	102	108	112	129	142	150	163	172	188	213	226	244	255	289	318	360	391	421	455	482	36
66"	120	105	112	129	139	150	163	172	188	204	226	244	256	276	309	340	388	417	457	491	525	37
72"	124	109	121	137	143	162	172	188	204	217	244	259	276	299	332	368	413	451	491	525	559	41
78"	134	118	133	142	150	170	184	200	217	230	256	276	299	313	359	391	443	477	522	559	596	42
84"	144	129	139	150	162	183	198	214	226	247	276	297	313	332	379	414	468	511	556	594	631	45
90"	152	137	147	158	170	194	213	223	244	256	289	309	327	356	398	443	491	538	585	630	673	48
96"	157	142	150	163	174	204	219	240	255	274	305	324	353	371	417	465	522	564	619	664	706	49
102"	162	147	162	172	188	213	230	248	266	288	322	342	368	391	443	489	550	596	648	697	749	52
108"	169	154	168	183	198	219	244	259	279	303	335	360	388	410	465	514	578	624	680	732	785	54
114"	177	162	172	194	206	230	251	274	297	313	356	379	406	429	482	538	601	652	717	781	847	60
120"	179	163	183	200	217	244	259	288	308	327	368	391	420	451	511	560	630	687	742	798	853	60
126"	186	170	194	213	223	251	276	299	318	340	384	413	443	468	529	585	657	714	770	827	881	61

**NOTE:** Smallest width available 5½" exact.  
Widths from 5½" to 8½" are center tilt only.  
143¾" max. single blind.

**Multiple Blinds on One Headrail** Blinds less than 142":  
**Add surcharge: \$46 two on one headrail**  
**\$64 three on one headrail**  
Blind widths 142" to 192": **No charge**

## COLORS

Alabaster . . . . . 112	Fawn . . . . . 031	Navajo White. . . . . 376	Vanilla . . . . . 100
Almond . . . . . 724	Flax . . . . . 541	Parchment . . . . . 535	White Gloss. . . . . 005
Almost White Gloss. . . 065	Forest Shadow. . . . . 087	Pitch Black. . . . . 033	White Satin . . . . . 205
Aluminum . . . . . 034	Granite. . . . . 044	Raw Umber . . . . . 006	
Beige . . . . . 011	Gray Dawn. . . . . 405	Real Red . . . . . 085	<b>PREMIUM COLORS</b>
Birch White . . . . . 375	Gray Haze . . . . . 983	Rock Gray . . . . . 399	<b>(10% Surcharge)</b>
Black Satin. . . . . 233	Greige . . . . . 122	Silver . . . . . 737	Alabaster Pearl . . . . . 326
Buff . . . . . 624	Hunter Green. . . . . 154	Skyline . . . . . 680	Ash Metallic. . . . . 126
Burgundy. . . . . 653	Ice . . . . . 778	Smokey Gray. . . . . 026	Beige Pearl . . . . . 328
Cameo . . . . . 607	Lamplight . . . . . 904	Snowcap White . . . . . 386	Brushed Aluminum . . . . 121
Char Brown . . . . . 062	Magnet . . . . . 648	Stucco . . . . . 963	Fawn Pearl. . . . . 327
Coconut. . . . . 630	Matte White. . . . . 042	Tender Taupe. . . . . 103	Polished Aluminum . . . . 741
Creamy Beige . . . . . 670	Mercury . . . . . 771	True Blue . . . . . 089	White Pearl . . . . . 637
Crystal White. . . . . 629	Midnight Blue . . . . . 057	True White. . . . . 544	
Desert Sand. . . . . 625	Milk Chocolate . . . . . 060	U.N. Gray. . . . . 095	

# Price Charts: Aluminum Blinds

## PRICE GROUP D: 1" INSIGNIA™ MINI BLINDS

### 1" SLATS .006 GAUGE

HEIGHT UP TO ↓	WIDTH UP TO →																			Add'l 10"
	12"	23"	26"	29"	32"	36"	40"	44"	48"	52"	57"	62"	67"	72"	82"	92"	102"	112"	120"	
42"	80	64	68	75	81	90	96	101	106	117	133	139	151	157	177	196	222	241	262	22
48"	84	68	75	82	89	97	104	112	118	126	145	154	162	174	196	217	244	263	291	24
54"	91	75	82	89	93	104	112	121	131	138	155	166	177	191	213	236	266	289	313	28
60"	97	82	89	93	100	112	121	133	139	151	169	179	194	203	231	254	289	311	342	30
66"	101	86	93	100	106	121	133	139	153	161	181	195	207	221	248	274	308	335	365	32
72"	105	90	98	105	113	129	139	151	161	170	195	209	221	236	266	293	330	359	393	34
78"	111	96	104	112	121	138	149	159	170	184	207	221	236	250	283	313	350	380	416	36
84"	116	101	108	118	131	145	155	170	181	195	221	235	250	266	301	330	372	406	443	38
90"	120	105	117	126	137	153	166	179	194	206	231	248	263	283	318	349	394	429	468	40
96"	128	112	121	134	145	161	174	191	202	219	244	260	278	296	335	371	416	453	493	41
102"	133	117	129	139	151	169	184	198	213	227	258	274	293	311	350	393	437	477	521	44
108"	138	122	134	146	157	176	194	209	225	241	267	289	308	326	371	412	462	500	543	45
114"	142	126	141	154	165	187	202	221	236	254	278	301	323	340	386	428	478	523	568	46
120"	148	133	147	161	174	195	210	231	246	266	292	315	336	353	401	445	498	545	592	49
126"	152	137	155	169	184	203	221	241	256	276	303	328	349	367	416	462	515	568	616	52

**NOTE:** Smallest width available 5½" exact.  
Widths from 5½" to 8¹⁵⁄₁₆" are center tilt only.

**Multiple Blinds on One Headrail** Blinds less than 120":  
**Add surcharge: \$46** two on one headrail  
**\$64** three on one headrail  
 Blind widths 120" to 192": **No charge**

## COLORS

Alabaster . . . . . 112  
 Almost White Gloss . . . 065  
 Aluminum . . . . . 034  
 Beige . . . . . 011  
 Black Satin . . . . . 233  
 Buff . . . . . 624  
 Burgundy . . . . . 653  
 Cameo . . . . . 607  
 Char Brown . . . . . 062  
 Coconut . . . . . 630  
 Creamy Beige . . . . . 670  
 Crystal White . . . . . 629  
 Desert Sand . . . . . 625

Fawn . . . . . 031  
 Flax . . . . . 541  
 Forest Shadow . . . . . 087  
 Granite . . . . . 044  
 Gray Haze . . . . . 983  
 Greige . . . . . 122  
 Ice . . . . . 778  
 Lamplight . . . . . 904  
 Matte White . . . . . 042  
 Milk Chocolate . . . . . 060  
 Parchment . . . . . 535  
 Pitch Black . . . . . 033  
 Raw Umber . . . . . 006

Real Red . . . . . 085  
 Silver . . . . . 737  
 Smokey Gray . . . . . 026  
 Snowcap White . . . . . 386  
 Stucco . . . . . 963  
 True Blue . . . . . 089  
 True White . . . . . 544  
 U.N. Gray . . . . . 095  
 Vanilla . . . . . 100  
 White Gloss . . . . . 005  
 White Satin . . . . . 205

**PREMIUM COLORS**  
**(10% Surcharge)**  
 Brushed Aluminum . . . . 121  
 Polished Aluminum . . . . 741

# Price Charts: Aluminum Blinds

## PRICE GROUP E: 1/2" MICRO SUPREME BLINDS

### 1/2" MICRO SUPREME BLINDS

HEIGHT UP TO ↓	WIDTH UP TO →																			Add'l 10"
	12"	23"	26"	29"	32"	36"	40"	44"	48"	52"	57"	62"	67"	72"	82"	92"	102"	112"	120"	
42"	\$104	89	94	100	108	124	133	143	151	162	184	194	210	222	250	276	311	340	369	32
48"	109	94	100	112	118	135	145	155	165	177	199	213	231	244	276	305	344	371	406	36
54"	115	100	112	121	126	145	157	166	181	194	214	235	250	267	299	335	372	405	441	37
60"	125	110	118	126	139	155	166	183	194	210	236	250	271	288	326	356	405	438	478	41
66"	133	117	126	139	149	166	183	194	210	223	252	270	292	309	349	386	436	470	513	42
72"	140	124	137	149	158	179	194	210	223	240	270	292	309	335	372	412	465	506	551	46
78"	148	133	145	157	166	192	207	223	240	256	289	307	335	350	398	440	495	536	587	48
84"	156	141	153	165	181	199	214	239	252	271	305	327	350	372	422	466	525	572	624	53
90"	164	149	162	176	191	210	235	248	270	287	322	346	371	397	447	493	558	605	659	54
96"	170	155	166	187	199	223	244	263	282	303	340	365	393	417	472	521	587	635	693	57
102"	179	163	179	194	210	236	256	275	297	316	359	381	412	438	495	548	615	671	731	60
108"	185	169	187	202	219	247	270	292	313	335	372	402	434	461	521	576	645	704	765	63

**NOTE:** Smallest width available 5 1/2" exact.  
Widths from 5 1/2" to 8 15/16" are center tilt only.

**Multiple Blinds on One Headrail** Blinds less than 120":  
**Add surcharge: \$46** two on one headrail  
**\$64** three on one headrail  
 Blind widths 120" to 192": **No charge**

## COLORS

Alabaster . . . . . 112  
 Almost White Gloss . . . 065  
 Aluminum . . . . . 034  
 Beige . . . . . 011  
 Black Satin . . . . . 233  
 Char Brown . . . . . 062  
 Creamy Beige . . . . . 670  
 Crystal White . . . . . 629

Fawn . . . . . 031  
 Flax . . . . . 541  
 Gray Haze . . . . . 983  
 Greige . . . . . 122  
 Lamplight . . . . . 904  
 Matte White . . . . . 042  
 Milk Chocolate . . . . . 060  
 Parchment . . . . . 535

Pitch Black . . . . . 033  
 Raw Umber . . . . . 006  
 Smokey Gray . . . . . 026  
 True White . . . . . 544  
 Vanilla . . . . . 100  
 White Gloss . . . . . 005  
 White Satin . . . . . 205

### PREMIUM COLORS (10% Surcharge)

Alabaster Pearl . . . . . 326  
 Brushed Aluminum . . . . 121  
 Fawn Pearl . . . . . 327

# Price Charts: Aluminum Blinds

## PRICE GROUP F: 2" GRANDEUR™ ALUMINUM

### 2" SLATS

HEIGHT UP TO	WIDTH UP TO →																				
	12"	23"	26"	29"	32"	36"	40"	44"	48"	52"	57"	62"	67"	72"	82"	92"	102"	112"	122"	132"	142"
42"	\$108	93	98	105	114	129	138	149	157	170	192	203	219	230	258	288	323	350	381	412	437
48"	113	98	105	118	126	141	153	162	174	187	209	223	240	254	288	315	354	384	421	450	478
54"	120	105	118	126	135	153	162	176	190	200	226	246	258	275	311	345	386	421	458	491	525
60"	133	117	126	135	146	162	176	192	203	221	247	260	282	297	337	369	421	455	498	530	567
66"	138	122	134	146	157	176	192	203	222	235	263	283	301	322	363	401	450	487	531	571	609
72"	146	131	143	155	165	188	202	221	235	250	283	305	322	345	386	428	480	525	571	611	653
78"	153	138	153	162	176	200	217	232	250	267	301	322	345	365	413	455	511	558	608	653	696
84"	162	147	158	174	190	209	226	248	263	283	320	344	365	386	440	481	542	592	644	692	736
90"	170	155	170	184	198	222	246	259	282	299	337	363	384	410	465	511	575	627	680	732	782
96"	177	162	176	194	209	235	254	275	295	318	354	380	406	432	489	539	608	661	718	769	826
102"	188	172	188	202	221	247	267	289	311	333	375	402	428	455	513	571	635	696	759	815	867
108"	193	177	195	210	230	256	282	305	327	350	389	421	450	476	539	600	669	726	794	853	911
114"	203	188	203	222	240	270	295	320	344	365	410	440	472	499	567	627	701	763	833	895	951
120"	209	194	210	231	250	282	305	330	356	380	428	458	491	523	592	656	733	798	872	934	995
126"	215	200	222	244	259	295	320	346	371	401	447	476	511	543	615	680	763	829	911	972	1036

**NOTE:** Smallest width available 9" exact. Widths from 9" to 11<sup>1</sup>/<sub>16</sub>" are center tilt only.

### 2" SLATS WITH CLOTH TAPES

HEIGHT UP TO	WIDTH UP TO →																				
	12"	23"	26"	29"	32"	36"	40"	44"	48"	52"	57"	62"	67"	72"	82"	92"	102"	112"	122"	132"	142"
42"	\$124	107	113	121	131	148	159	171	181	196	221	233	252	265	297	331	371	403	438	474	503
48"	130	113	121	136	145	162	176	186	200	215	240	256	276	292	331	362	407	442	484	518	550
54"	138	121	136	145	155	176	186	202	219	230	260	283	297	316	358	397	444	484	527	565	604
60"	153	135	145	155	168	186	202	221	233	254	284	299	324	342	388	424	484	523	573	610	652
66"	159	140	154	168	181	202	221	233	255	270	302	325	346	370	417	461	518	560	611	657	700
72"	168	151	164	178	190	216	232	254	270	288	325	351	370	397	444	492	552	604	657	703	751
78"	176	159	176	186	202	230	250	267	288	307	346	370	397	420	475	523	588	642	699	751	800
84"	186	169	182	200	219	240	260	285	302	325	368	396	420	444	506	553	623	681	741	796	846
90"	196	178	196	212	228	255	283	298	324	344	388	417	442	472	535	588	661	721	782	842	899
96"	204	186	202	223	240	270	292	316	339	366	407	437	467	497	562	620	699	760	826	884	950
102"	216	198	216	232	254	284	307	332	358	383	431	462	492	523	590	657	730	800	873	937	997
108"	222	204	224	242	265	294	324	351	376	403	447	484	518	547	620	690	769	835	913	981	1048
114"	233	216	233	255	276	311	339	368	396	420	472	506	543	574	652	721	806	877	958	1029	1094
120"	240	223	242	266	288	324	351	380	409	437	492	527	565	601	681	754	843	918	1003	1074	1144
126"	247	230	255	281	298	339	368	398	427	461	514	547	588	624	707	782	877	953	1048	1118	1191

**NOTE:** Smallest width available 9" exact. Widths from 9" to 11<sup>1</sup>/<sub>16</sub>" are center tilt only.

## COLORS

Alabaster . . . . . 112  
 Almond . . . . . 724  
 Almost White Gloss . . . 065  
 Black Satin . . . . . 233  
 Char Brown . . . . . 062  
 Creamy Beige . . . . . 670  
 Gray Haze . . . . . 983  
 Greige . . . . . 122

Hunter Green . . . . . 154  
 Lamplight . . . . . 904  
 Raw Umber . . . . . 006  
 Snowcap White . . . . . 386  
 Stucco . . . . . 963  
 True White . . . . . 544  
 White Gloss . . . . . 005  
 White Satin . . . . . 205

### PREMIUM COLORS (10% Surcharge)

Alabaster Pearl . . . . . 326  
 Ash Metallic . . . . . 126  
 Brushed Aluminum . . . 121  
 Polished Aluminum . . . 741

# Price Charts: Specialty Shapes

## PRICE GROUP G: 1" SKYLIGHTS

### DUAL HEADRAIL AND INCLINE WIRE BLINDS .006 GAUGE

HEIGHT UP TO	WIDTH UP TO →																122"	132"	142"		
	12"	23"	26"	29"	32"	36"	40"	44"	48"	52"	57"	62"	67"	72"	82"	92"				102"	112"
42"	\$186	170	183	188	198	246	255	262	272	279	327	349	365	375	438	465	507	531	560	605	649
48"	198	183	192	198	207	259	270	278	289	299	349	372	386	402	473	502	545	576	603	652	700
54"	203	188	200	207	219	274	287	295	305	315	372	397	410	428	507	533	582	615	645	699	752
60"	211	196	207	217	230	289	301	309	322	333	393	420	437	450	533	570	624	659	690	748	805
66"	218	203	219	226	241	303	313	326	340	353	416	443	465	478	572	605	665	700	736	797	857
72"	228	213	227	239	252	315	328	342	356	371	437	468	489	506	587	639	706	740	780	843	906
78"	239	223	240	250	266	333	345	357	371	379	466	498	517	540	640	683	758	798	835	903	971
84"	245	230	247	258	274	342	357	376	389	404	478	513	536	558	665	709	781	826	868		
90"	254	239	258	267	287	357	376	391	405	421	502	536	563	582	699	741	822	867	915		
96"	261	246	266	276	296	372	389	405	421	440	525	560	587	608	729	778					
102"	270	255	275	289	307	388	404	421	443	461	545	582	609	612	762	813					
108"	275	260	283	296	316	401	417	438	458	476	567										
114"	287	271	295	307	328																
120"	294	278	301	315	341																
126"	304	289	309	326	353																

Incline wire available only in sizes to the left of the dotted line.

Dual Headrail available only in sizes above the heavy line.

### DUAL HEADRAIL AND INCLINE WIRE BLINDS .008 GAUGE

HEIGHT UP TO	WIDTH UP TO →																122"	132"	142"		
	12"	23"	26"	29"	32"	36"	40"	44"	48"	52"	57"	62"	67"	72"	82"	92"				102"	112"
42"	\$203	188	200	206	217	270	279	289	301	308	360	384	402	413	481	511	558	585	616	665	714
48"	215	200	211	217	227	287	297	307	318	327	384	410	425	443	521	552	600	634	663	717	770
54"	221	206	219	227	243	303	313	323	336	348	410	436	451	472	558	587	641	676	710	769	827
60"	231	215	227	240	252	318	332	341	354	367	431	462	480	495	587	627	687	724	759	822	886
66"	239	223	243	250	264	333	345	359	372	388	458	487	511	526	630	665	732	770	811	876	942
72"	250	235	251	262	276	348	363	375	391	409	480	514	538	556	645	704	776	814	859	927	997
78"	262	247	263	274	293	367	379	394	409	417	513	548	568	595	705	752	833	878	920	995	1068
84"	267	252	271	283	303	375	394	414	428	445	526	564	590	613	732	780	860	908	955		
90"	277	262	283	295	313	394	414	429	446	463	552	590	619	641	769	815	904	954	1005		
96"	286	270	293	305	324	410	428	446	463	482	578	616	645	668	802	857					
102"	295	279	304	318	337	426	445	463	487	507	600	641	671	673	837	894					
108"	303	288	311	324	349	441	459	481	505	523	624										
114"	314	299	323	337	363																
120"	322	307	332	348	373																
126"	334	318	341	359	388																

Incline wire available only in sizes to the left of the dotted line.

Dual Headrail available only in sizes above the heavy line.

## COLORS

Alabaster . . . . . 112	Forest Shadow . . . . . 087	Real Red . . . . . 085
Almond . . . . . 724	Granite . . . . . 044	Rock Gray . . . . . 399
Almost White Gloss . . . 065	Gray Dawn . . . . . 405	Silver . . . . . 737
Aluminum . . . . . 034	Gray Haze . . . . . 983	Skyline . . . . . 680
Beige . . . . . 011	Greige . . . . . 122	Smokey Gray . . . . . 026
Birch White . . . . . 375	Hunter Green . . . . . 154	Snowcap White . . . . . 386
Black Satin . . . . . 233	Ice . . . . . 778	Stucco . . . . . 963
Buff . . . . . 624	Lamplight . . . . . 904	Tender Taupe . . . . . 103
Burgundy . . . . . 653	Magnet . . . . . 648	True Blue . . . . . 089
Cameo . . . . . 607	Matte White . . . . . 042	True White . . . . . 544
Char Brown . . . . . 062	Mercury . . . . . 771	U.N. Gray . . . . . 095
Coconut . . . . . 630	Midnight Blue . . . . . 057	Vanilla . . . . . 100
Creamy Beige . . . . . 670	Milk Chocolate . . . . . 060	White Gloss . . . . . 005
Crystal White . . . . . 629	Navajo White . . . . . 376	White Satin . . . . . 205
Desert Sand . . . . . 625	Parchment . . . . . 535	
Fawn . . . . . 031	Pitch Black . . . . . 033	
Flax . . . . . 541	Raw Umber . . . . . 006	

### PREMIUM COLORS (10% Surcharge)

Alabaster Pearl . . . . . 326
Ash Metallic . . . . . 126
Beige Pearl . . . . . 328
Brushed Aluminum . . . 121
Fawn Pearl . . . . . 327
Polished Aluminum . . . 741
White Pearl . . . . . 637

# Price Charts: Specialty Shapes

## PRICE GROUP H: 1" SKYLIGHTS—INCLINE WIRE SPECIALTY SHAPES

INCLINE WIRE: SIDE CUTS, INVERTED TRIANGLES, ANGLE TOPS AND BOTTOMS .006 GAUGE

HEIGHT UP TO	WIDTH UP TO →																		
	12"	23"	26"	29"	32"	36"	40"	44"	48"	52"	57"	62"	67"	72"	82"	92"	102"	112"	122"
42"	\$472	457	468	473	482	564	574	581	592	632	680	701	718	770	833	860	969	995	1022
48"	483	468	477	482	493	578	590	599	608	652	701	725	740	797	868	896	1007	1039	1064
54"	489	473	486	493	506	594	605	613	624	668	725	749	763	823	902	928	1044	1077	1108
60"	497	481	493	503	515	608	620	628	641	685	745	773	789	845	928	965	1086	1121	1153
66"	504	489	506	513	526	622	632	645	659	706	769	795	818	874	968	1000	1127	1162	1199
72"	514	499	514	523	538	634	648	661	675	724	789	821	842	900	981	1033	1167	1202	1242
78"	525	510	525	534	552	653	664	676	690	732	819	850	870	935	1035	1078	1219	1260	1298
84"	530	515	531	543	560	661	676	696	709	757	831	866	889	952	1060	1104	1243	1288	1331
90"	539	523	543	554	571	676	696	710	724	774	854	889	916	977	1093	1135	1284	1329	1376
96"	546	530	552	563	581	692	709	724	741	793	878	913	939	1003	1125	1174			
102"	555	540	562	574	592	708	722	741	762	814	898	935	963	1007	1157	1207			
108"	562	547	568	581	603	720	736	758	777	829	920								
114"	573	558	579	592	615														
120"	579	564	587	601	626														
126"	590	574	595	612	639														

INCLINE WIRE: SIDE CUTS, INVERTED TRIANGLES, ANGLE TOPS AND BOTTOMS .008 GAUGE

HEIGHT UP TO	WIDTH UP TO →																		
	12"	23"	26"	29"	32"	36"	40"	44"	48"	52"	57"	62"	67"	72"	82"	92"	102"	112"	122"
42"	\$489	473	486	491	503	590	600	608	620	661	713	736	755	809	876	906	1020	1048	1078
48"	501	486	498	503	514	605	616	626	636	680	736	763	778	837	916	951	1061	1097	1125
54"	506	491	506	514	527	622	632	643	656	700	763	788	804	867	952	981	1104	1138	1172
60"	517	502	514	525	538	636	652	660	673	720	784	815	833	889	981	1022	1150	1186	1221
66"	525	510	527	534	551	653	664	677	692	741	811	840	864	922	1025	1060	1194	1232	1272
72"	534	519	536	548	563	667	681	695	710	762	833	867	890	951	1040	1098	1238	1276	1320
78"	547	531	550	560	578	685	699	713	728	770	866	900	922	990	1099	1146	1295	1340	1382
84"	553	538	558	568	588	695	713	733	748	797	879	918	942	1008	1127	1175	1321	1371	1417
90"	563	548	568	579	600	713	733	749	765	817	904	942	972	1036	1163	1210	1367	1416	1467
96"	571	556	578	591	611	729	748	765	782	835	931	969	999	1062	1197	1252			
102"	581	566	590	604	623	746	763	782	807	860	952	995	1024	1069	1232	1288			
108"	588	572	596	611	634	761	778	801	823	876	977								
114"	599	583	609	623	648														
120"	607	592	618	632	660														
126"	619	604	626	644	673														

## COLORS

Alabaster . . . . .	112	Forest Shadow. . . . .	087	Real Red . . . . .	085
Almond . . . . .	724	Granite. . . . .	044	Rock Gray . . . . .	399
Almost White Gloss. . .	065	Gray Dawn. . . . .	405	Silver . . . . .	737
Aluminum . . . . .	034	Gray Haze . . . . .	983	Skyline . . . . .	680
Beige . . . . .	011	Greige . . . . .	122	Smokey Gray. . . . .	026
Birch White . . . . .	375	Hunter Green. . . . .	154	Snowcap White . . . . .	386
Black Satin. . . . .	233	Ice . . . . .	778	Stucco . . . . .	963
Buff . . . . .	624	Lamplight . . . . .	904	Tender Taupe. . . . .	103
Burgundy. . . . .	653	Magnet . . . . .	648	True Blue. . . . .	089
Cameo. . . . .	607	Matte White. . . . .	042	True White. . . . .	544
Char Brown . . . . .	062	Mercury . . . . .	771	U.N. Gray. . . . .	095
Coconut. . . . .	630	Midnight Blue . . . . .	057	Vanilla . . . . .	100
Creamy Beige . . . . .	670	Milk Chocolate . . . . .	060	White Gloss. . . . .	005
Crystal White. . . . .	629	Navajo White. . . . .	376	White Satin . . . . .	205
Desert Sand. . . . .	625	Parchment . . . . .	535		
Fawn . . . . .	031	Pitch Black. . . . .	033		
Flax . . . . .	541	Raw Umber . . . . .	006		

### PREMIUM COLORS (10% Surcharge)

Alabaster Pearl . . . . .	326
Ash Metallic. . . . .	126
Beige Pearl . . . . .	328
Brushed Aluminum . . .	121
Fawn Pearl. . . . .	327
Polished Aluminum . . .	741
White Pearl . . . . .	637

# Price Charts: Specialty Shapes

## PRICE GROUP H: 1" SKYLIGHTS—INCLINE WIRE SPECIALTY SHAPES

### INCLINE WIRE: OCTAGONS, TRIANGLES AND OTHER SHAPES

.006 GAUGE

HEIGHT UP TO	WIDTH UP TO →																		
	12"	23"	26"	29"	32"	36"	40"	44"	48"	52"	57"	62"	67"	72"	82"	92"	102"	112"	122"
42"	\$565	550	560	566	575	673	683	690	701	759	807	827	845	930	992	1020	1162	1187	1215
48"	575	560	570	575	585	687	699	708	717	777	827	851	866	956	1028	1056	1200	1232	1258
54"	581	566	578	585	599	704	714	722	733	794	851	875	889	983	1061	1088	1238	1270	1301
60"	590	574	585	595	608	717	729	737	750	813	871	899	916	1004	1088	1125	1280	1313	1345
66"	597	581	599	605	619	731	742	755	768	831	895	922	944	1033	1127	1159	1320	1356	1392
72"	606	591	607	616	630	744	758	770	784	850	916	947	968	1060	1141	1193	1361	1394	1435
78"	618	603	618	627	644	762	773	785	799	859	945	976	996	1094	1194	1238	1413	1454	1491
84"	623	608	624	635	653	770	785	805	818	882	958	991	1016	1112	1219	1263	1437	1481	1523
90"	631	616	635	645	664	785	805	819	833	900	980	1016	1041	1137	1254	1295	1477	1522	1570
96"	639	623	644	656	673	801	818	833	850	919	1004	1039	1065	1162	1284	1333			
102"	648	632	655	667	684	817	831	850	871	939	1024	1061	1088	1166	1316	1367			
108"	654	639	661	673	695	829	846	867	886	955	1046								
114"	664	649	672	684	708														
120"	672	657	679	693	718														
126"	682	667	687	705	731														

### INCLINE WIRE: OCTAGONS, TRIANGLES AND OTHER SHAPES

.008 GAUGE

HEIGHT UP TO	WIDTH UP TO →																		
	12"	23"	26"	29"	32"	36"	40"	44"	48"	52"	57"	62"	67"	72"	82"	92"	102"	112"	122"
42"	\$581	566	578	583	595	699	709	717	729	786	838	863	881	968	1036	1065	1212	1240	1271
48"	594	578	590	595	607	714	725	735	746	807	863	889	904	997	1076	1106	1255	1290	1317
54"	599	583	599	607	620	731	742	752	765	826	889	915	930	1026	1112	1141	1296	1332	1365
60"	609	594	607	618	630	746	761	769	782	846	911	940	959	1049	1141	1182	1343	1380	1414
66"	618	603	620	627	643	762	773	786	801	867	936	967	990	1081	1185	1219	1388	1425	1466
72"	627	612	628	640	656	776	791	804	819	887	959	992	1017	1110	1200	1258	1431	1469	1514
78"	640	624	641	653	671	795	809	822	837	896	991	1026	1048	1150	1259	1307	1489	1533	1575
84"	646	630	649	661	680	804	822	843	857	923	1005	1043	1069	1167	1287	1335	1515	1564	1611
90"	655	640	661	672	692	822	843	859	874	942	1031	1069	1098	1195	1323	1369	1560	1609	1661
96"	663	648	671	683	704	838	857	874	891	963	1057	1094	1125	1223	1357	1412			
102"	674	659	681	696	716	855	872	891	916	985	1078	1121	1150	1228	1392	1448			
108"	680	665	689	704	726	870	887	911	932	1003	1104								
114"	692	676	701	716	741														
120"	700	684	710	725	752														
126"	711	696	718	736	766														

## COLORS

Alabaster . . . . . 112	Forest Shadow . . . . . 087	Real Red . . . . . 085	<b>PREMIUM COLORS (10% Surcharge)</b>
Almond . . . . . 724	Granite . . . . . 044	Rock Gray . . . . . 399	
Almost White Gloss . . . 065	Gray Dawn . . . . . 405	Silver . . . . . 737	
Aluminum . . . . . 034	Gray Haze . . . . . 983	Skyline . . . . . 680	
Beige . . . . . 011	Greige . . . . . 122	Smokey Gray . . . . . 026	
Birch White . . . . . 375	Hunter Green . . . . . 154	Snowcap White . . . . . 386	
Black Satin . . . . . 233	Ice . . . . . 778	Stucco . . . . . 963	
Buff . . . . . 624	Lamplight . . . . . 904	Tender Taupe . . . . . 103	
Burgundy . . . . . 653	Magnet . . . . . 648	True Blue . . . . . 089	
Cameo . . . . . 607	Matte White . . . . . 042	True White . . . . . 544	
Char Brown . . . . . 062	Mercury . . . . . 771	U.N. Gray . . . . . 095	
Coconut . . . . . 630	Midnight Blue . . . . . 057	Vanilla . . . . . 100	
Creamy Beige . . . . . 670	Milk Chocolate . . . . . 060	White Gloss . . . . . 005	
Crystal White . . . . . 629	Navajo White . . . . . 376	White Satin . . . . . 205	
Desert Sand . . . . . 625	Parchment . . . . . 535		
Fawn . . . . . 031	Pitch Black . . . . . 033		
Flax . . . . . 541	Raw Umber . . . . . 006		

# Price Charts: Specialty Shapes

## PRICE GROUP I: ARCHES

### 1" SLATS .006 GAUGE

HEIGHT UP TO	WIDTH UP TO →																				
	23"	23"	26"	29"	32"	36"	40"	44"	48"	52"	57"	62"	67"	72"	82"	92"	102"	112"	122"	132"	142"
42"	\$664	649	653	659	668	675	684	696	789	797	813	821	834	843	867	887	951	971	1024	1049	1064
48"	768	753	759	770	776	788	797	807	847	859	876	886	899	940	968	992	1056	1077	1140	1165	1187
54"	845	829	840	846	850	867	876	883	928	936	960	975	984	1031	1056	1085	1150	1177	1238	1264	1292
60"	926	911	916	920	935	947	954	967	1008	1022	1044	1057	1073	1114	1145	1172	1246	1275	1336	1365	1392
66"	997	981	988	1004	1012	1022	1035	1043	1090	1106	1126	1141	1153	1204	1234	1260	1340	1367	1435	1467	1498
72"	1127	1112	1123	1135	1142	1159	1169	1183	1208	1219	1243	1258	1275	1294	1323	1357	1522	1558	1607	1636	1668
78"	1206	1190	1202	1211	1218	1238	1248	1264	1290	1301	1324	1344	1364	1377	1418	1448	1619	1651	1704	1737	1771
84"	1285	1270	1279	1288	1299	1317	1332	1347	1368	1386	1414	1433	1448	1463	1507	1539	1713	1752	1805	1838	1874
90"	1291	1276	1285	1296	1308	1328	1345	1356	1384	1394	1424	1444	1461	1486	1523	1564	1733	1776	1831	1872	1911
96"	1296	1281	1288	1301	1312	1339	1353	1369	1393	1412	1440	1458	1483	1499	1542	1584	1762	1799	1863	1903	1940
102"	1301	1285	1299	1309	1323	1345	1361	1377	1405	1422	1455	1473	1497	1518	1564	1607	1785	1829	1889	1934	1980
108"	1308	1292	1305	1317	1332	1353	1373	1388	1417	1437	1466	1490	1515	1535	1584	1630	1813	1854	1919	1965	2013
114"	1315	1299	1309	1328	1340	1361	1381	1401	1433	1448	1486	1507	1531	1553	1602	1651	1833	1879	1951	2009	2070
120"	1316	1301	1317	1335	1349	1373	1388	1413	1442	1461	1497	1518	1544	1572	1627	1672	1859	1911	1975	2025	2076
126"	1323	1308	1328	1345	1356	1381	1405	1424	1450	1470	1511	1538	1564	1588	1644	1694	1883	1936	1999	2051	2100

### 1" SLATS .008 GAUGE

HEIGHT UP TO	WIDTH UP TO →																				
	23"	23"	26"	29"	32"	36"	40"	44"	48"	52"	57"	62"	67"	72"	82"	92"	102"	112"	122"	132"	142"
42"	\$672	657	660	667	677	684	696	709	802	811	827	835	851	862	887	911	976	999	1053	1081	1098
48"	776	761	768	780	785	799	810	819	862	874	894	904	918	960	990	1018	1084	1106	1172	1200	1226
54"	853	837	850	855	860	879	889	898	944	952	979	995	1005	1053	1080	1112	1181	1208	1272	1303	1333
60"	935	920	926	930	947	959	968	981	1024	1039	1064	1078	1094	1138	1172	1202	1279	1309	1373	1408	1435
66"	1007	991	999	1016	1025	1036	1050	1058	1108	1125	1146	1163	1177	1230	1262	1291	1375	1405	1477	1513	1546
72"	1137	1122	1134	1149	1155	1175	1185	1200	1227	1239	1266	1281	1299	1320	1354	1390	1560	1598	1651	1684	1718
78"	1217	1202	1214	1224	1232	1254	1266	1283	1309	1321	1348	1369	1390	1406	1450	1483	1660	1694	1752	1788	1826
84"	1296	1281	1291	1303	1315	1335	1349	1367	1389	1409	1440	1459	1476	1494	1542	1576	1754	1798	1855	1893	1931
90"	1304	1288	1299	1311	1323	1345	1365	1376	1406	1418	1450	1471	1490	1518	1560	1604	1778	1825	1884	1930	1972
96"	1310	1294	1303	1316	1328	1357	1372	1392	1417	1437	1467	1487	1515	1533	1579	1627	1809	1851	1919	1964	2005
102"	1315	1299	1315	1324	1340	1365	1382	1400	1428	1449	1485	1503	1530	1553	1604	1651	1835	1883	1947	1996	2048
108"	1322	1307	1320	1335	1349	1372	1396	1412	1442	1465	1497	1522	1550	1572	1627	1676	1866	1911	1980	2032	2085
114"	1330	1315	1324	1345	1358	1382	1404	1426	1459	1476	1518	1542	1568	1592	1645	1700	1887	1938	2017	2081	2146
120"	1331	1316	1335	1353	1369	1396	1412	1440	1470	1490	1530	1553	1582	1613	1673	1722	1917	1975	2041	2097	2152
126"	1338	1323	1345	1365	1376	1404	1429	1450	1480	1501	1546	1575	1604	1630	1692	1748	1943	2000	2070	2127	2180

Template Service Fee (see page 18 for explanation): \$25 (net price)

## COLORS

Alabaster . . . . .	112
Almond . . . . .	724
Almost White Gloss . . .	065
Aluminum . . . . .	034
Beige . . . . .	011
Birch White . . . . .	375
Black Satin . . . . .	233
Buff . . . . .	624
Burgundy . . . . .	653
Cameo . . . . .	607
Char Brown . . . . .	062
Coconut . . . . .	630
Creamy Beige . . . . .	670
Crystal White . . . . .	629
Desert Sand . . . . .	625
Fawn . . . . .	031
Flax . . . . .	541

Forest Shadow . . . . .	087
Granite . . . . .	044
Gray Dawn . . . . .	405
Gray Haze . . . . .	983
Greige . . . . .	122
Hunter Green . . . . .	154
Ice . . . . .	778
Lamplight . . . . .	904
Magnet . . . . .	648
Matte White . . . . .	042
Mercury . . . . .	771
Midnight Blue . . . . .	057
Milk Chocolate . . . . .	060
Navajo White . . . . .	376
Parchment . . . . .	535
Pitch Black . . . . .	033
Raw Umber . . . . .	006

Real Red . . . . .	085
Rock Gray . . . . .	399
Silver . . . . .	737
Skyline . . . . .	680
Smokey Gray . . . . .	026
Snowcap White . . . . .	386
Stucco . . . . .	963
Tender Taupe . . . . .	103
True Blue . . . . .	089
True White . . . . .	544
U.N. Gray . . . . .	095
Vanilla . . . . .	100
White Gloss . . . . .	005
White Satin . . . . .	205

### PREMIUM COLORS (10% Surcharge)

Alabaster Pearl . . . . .	326
Ash Metallic . . . . .	126
Beige Pearl . . . . .	328
Brushed Aluminum . . .	121
Fawn Pearl . . . . .	327
Polished Aluminum . . .	741
White Pearl . . . . .	637



# Price Charts: Specialty Shapes

## PRICE GROUP J: CIRCLES

To price use larger number for width.

### 1" SLATS .006 GAUGE

HEIGHT UP TO	WIDTH UP TO →													
	12"	23"	26"	29"	32"	36"	40"	44"	48"	52"	57"	62"	67"	72"
42"	\$631	616	667	721	778	850	924	1000	1080	1151	1247	1336	1429	1519
48"	634	619	672	732	785	863	935	1009	1089	1165	1264	1354	1446	1538
54"	640	624	683	737	789	871	945	1017	1101	1174	1279	1372	1462	1558
60"	651	635	689	742	805	881	952	1029	1110	1189	1292	1385	1480	1571
66"	654	639	693	758	814	887	965	1037	1125	1204	1305	1400	1491	1592
72"	658	643	701	763	818	899	973	1052	1140	1215	1320	1414	1511	1612

### 1" SLATS .008 GAUGE

HEIGHT UP TO	WIDTH UP TO →													
	12"	23"	26"	29"	32"	36"	40"	44"	48"	52"	57"	62"	67"	72"
42"	\$639	623	673	729	788	860	935	1012	1092	1165	1263	1352	1446	1538
48"	642	626	680	742	795	874	948	1022	1104	1181	1281	1372	1465	1558
54"	648	632	693	748	799	883	958	1031	1116	1189	1296	1392	1483	1579
60"	660	645	699	752	817	894	967	1044	1126	1206	1312	1406	1502	1595
66"	663	648	704	769	826	902	980	1053	1141	1223	1327	1422	1515	1617
72"	668	653	713	776	830	915	988	1069	1158	1235	1343	1438	1536	1639

Template Service Fee (see page 18 for explanation): \$25 (net price)

## COLORS

Alabaster . . . . . 112  
 Almond . . . . . 724  
 Almost White Gloss . . . 065  
 Aluminum . . . . . 034  
 Beige . . . . . 011  
 Birch White . . . . . 375  
 Black Satin . . . . . 233  
 Buff . . . . . 624  
 Burgundy . . . . . 653  
 Cameo . . . . . 607  
 Char Brown . . . . . 062  
 Coconut . . . . . 630  
 Creamy Beige . . . . . 670  
 Crystal White . . . . . 629  
 Desert Sand . . . . . 625  
 Fawn . . . . . 031  
 Flax . . . . . 541

Forest Shadow . . . . . 087  
 Granite . . . . . 044  
 Gray Dawn . . . . . 405  
 Gray Haze . . . . . 983  
 Greige . . . . . 122  
 Hunter Green . . . . . 154  
 Ice . . . . . 778  
 Lamplight . . . . . 904  
 Magnet . . . . . 648  
 Matte White . . . . . 042  
 Mercury . . . . . 771  
 Midnight Blue . . . . . 057  
 Milk Chocolate . . . . . 060  
 Navajo White . . . . . 376  
 Parchment . . . . . 535  
 Pitch Black . . . . . 033  
 Raw Umber . . . . . 006

Real Red . . . . . 085  
 Rock Gray . . . . . 399  
 Silver . . . . . 737  
 Skyline . . . . . 680  
 Smokey Gray . . . . . 026  
 Snowcap White . . . . . 386  
 Stucco . . . . . 963  
 Tender Taupe . . . . . 103  
 True Blue . . . . . 089  
 True White . . . . . 544  
 U.N. Gray . . . . . 095  
 Vanilla . . . . . 100  
 White Gloss . . . . . 005  
 White Satin . . . . . 205

### PREMIUM COLORS (10% Surcharge)

Alabaster Pearl . . . . . 326  
 Ash Metallic . . . . . 126  
 Beige Pearl . . . . . 328  
 Brushed Aluminum . . . 121  
 Fawn Pearl . . . . . 327  
 Polished Aluminum . . . 741  
 White Pearl . . . . . 637

# Price Charts: Specialty Shapes

## PRICE GROUP K: SIDE CUTS, INVERTED TRIANGLES, ANGLE TOP AND BOTTOM

### 1" SLATS .006 GAUGE

HEIGHT UP TO	WIDTH UP TO →																				
	12"	23"	26"	29"	32"	36"	40"	44"	48"	52"	57"	62"	67"	72"	82"	92"	102"	112"	122"	132"	142"
42"	\$374	359	361	367	376	417	426	438	446	486	502	510	523	574	599	619	717	736	761	878	894
48"	376	361	367	377	384	429	438	449	455	500	518	527	540	592	619	644	740	761	789	907	930
54"	383	367	377	384	388	438	449	455	466	509	531	547	556	612	636	667	763	789	818	936	965
60"	393	377	384	388	404	449	455	468	476	523	547	559	574	626	657	683	789	818	846	968	995
66"	396	380	388	404	412	455	468	476	490	539	559	574	585	647	676	704	815	842	876	1001	1032
72"	400	385	397	409	416	466	476	490	506	551	574	588	605	667	696	729	837	872	908	1032	1062
78"	409	394	405	414	421	474	486	502	517	562	585	605	624	680	721	750	864	896	936	1062	1097
84"	419	404	412	421	432	485	499	514	525	576	605	623	639	696	740	772	887	927	968	1093	1129
90"	424	409	418	429	441	495	513	522	540	585	615	634	652	718	757	797	908	951	995	1127	1166
96"	429	414	421	434	446	506	519	536	551	603	630	648	673	732	774	818	936	975	1025	1158	1195
102"	434	418	432	443	457	513	527	545	562	613	645	664	687	750	797	838	960	1004	1052	1189	1235
108"	441	425	438	451	465	519	540	555	574	627	657	680	706	768	818	863	987	1029	1081	1219	1268
114"	448	432	443	461	473	527	548	568	590	639	676	697	722	785	834	883	1008	1054	1113	1264	1324
120"	449	434	451	468	482	540	555	579	600	652	687	709	735	805	860	904	1035	1086	1137	1280	1331
126"	456	441	461	478	489	548	571	591	608	661	701	728	755	821	876	927	1058	1112	1162	1307	1356

### 1" SLATS .008 GAUGE

HEIGHT UP TO	WIDTH UP TO →																				
	12"	23"	26"	29"	32"	36"	40"	44"	48"	52"	57"	62"	67"	72"	82"	92"	102"	112"	122"	132"	142"
42"	\$380	365	368	375	386	426	438	451	458	500	517	525	540	592	619	641	742	765	789	911	927
48"	384	368	375	388	394	441	451	461	469	515	534	547	559	612	641	669	768	789	822	942	968
54"	391	375	388	394	398	451	461	469	481	523	551	566	576	634	661	693	794	822	853	975	1005
60"	403	388	394	398	414	461	469	482	491	540	566	579	596	649	683	713	822	853	883	1009	1037
66"	406	391	398	414	424	469	482	491	507	558	579	596	609	672	705	733	850	879	919	1046	1080
72"	411	396	408	421	428	481	491	507	523	570	596	612	630	693	726	763	875	913	954	1080	1113
78"	420	405	417	426	436	490	503	519	536	582	609	630	652	709	753	785	904	939	984	1113	1151
84"	429	414	424	436	449	502	517	533	547	600	630	649	667	726	774	810	930	973	1018	1149	1186
90"	437	421	432	445	457	513	531	543	563	609	641	663	680	750	793	837	954	1000	1048	1185	1228
96"	442	426	436	450	461	523	539	559	574	627	659	677	706	766	813	860	984	1026	1081	1218	1260
102"	448	432	449	458	473	531	550	567	585	640	675	695	721	785	837	883	1011	1058	1110	1252	1304
108"	455	440	454	468	482	539	563	578	600	656	687	713	741	805	860	908	1040	1086	1142	1287	1340
114"	464	449	458	478	491	550	570	594	616	667	709	732	759	825	878	932	1062	1113	1179	1336	1401
120"	465	450	468	486	503	563	578	607	627	680	721	744	773	846	906	955	1092	1150	1204	1353	1408
126"	472	457	478	499	510	570	596	618	636	692	736	766	795	863	924	980	1119	1177	1232	1382	1435

Template Service Fee (see page 18 for explanation): \$25 (net price)

### COLORS

Alabaster . . . . . 112  
 Almond . . . . . 724  
 Almost White Gloss . . . 065  
 Aluminum . . . . . 034  
 Beige . . . . . 011  
 Birch White . . . . . 375  
 Black Satin . . . . . 233  
 Buff . . . . . 624  
 Burgundy . . . . . 653  
 Cameo . . . . . 607  
 Char Brown . . . . . 062  
 Coconut . . . . . 630  
 Creamy Beige . . . . . 670  
 Crystal White . . . . . 629  
 Desert Sand . . . . . 625  
 Fawn . . . . . 031  
 Flax . . . . . 541

Forest Shadow . . . . . 087  
 Granite . . . . . 044  
 Gray Dawn . . . . . 405  
 Gray Haze . . . . . 983  
 Greige . . . . . 122  
 Hunter Green . . . . . 154  
 Ice . . . . . 778  
 Lamplight . . . . . 904  
 Magnet . . . . . 648  
 Matte White . . . . . 042  
 Mercury . . . . . 771  
 Midnight Blue . . . . . 057  
 Milk Chocolate . . . . . 060  
 Navajo White . . . . . 376  
 Parchment . . . . . 535  
 Pitch Black . . . . . 033  
 Raw Umber . . . . . 006

Real Red . . . . . 085  
 Rock Gray . . . . . 399  
 Silver . . . . . 737  
 Skyline . . . . . 680  
 Smokey Gray . . . . . 026  
 Snowcap White . . . . . 386  
 Stucco . . . . . 963  
 Tender Taupe . . . . . 103  
 True Blue . . . . . 089  
 True White . . . . . 544  
 U.N. Gray . . . . . 095  
 Vanilla . . . . . 100  
 White Gloss . . . . . 005  
 White Satin . . . . . 205

### PREMIUM COLORS (10% Surcharge)

Alabaster Pearl . . . . . 326  
 Ash Metallic . . . . . 126  
 Beige Pearl . . . . . 328  
 Brushed Aluminum . . . 121  
 Fawn Pearl . . . . . 327  
 Polished Aluminum . . . 741  
 White Pearl . . . . . 637

# Price Charts: Specialty Shapes

## PRICE GROUP L: OCTAGONS, TRIANGLES

### 1" SLATS .006 GAUGE

HEIGHT UP TO	WIDTH UP TO →																				
	12"	23"	26"	29"	32"	36"	40"	44"	48"	52"	57"	62"	67"	72"	82"	92"	102"	112"	122"	132"	142"
42"	\$466	451	454	459	469	526	536	548	555	612	627	635	649	733	758	778	911	930	954	1080	1094
48"	469	454	459	470	476	539	548	558	564	626	644	655	667	752	778	804	932	954	983	1109	1131
54"	474	459	470	476	480	548	558	564	575	634	659	672	681	772	797	826	956	983	1011	1138	1166
60"	486	470	476	480	496	558	564	576	585	649	672	684	700	785	817	843	983	1011	1039	1169	1195
66"	489	473	480	496	505	564	576	585	600	665	684	700	712	807	835	863	1008	1035	1070	1203	1234
72"	493	477	489	502	509	575	585	600	615	676	700	714	731	826	855	889	1031	1065	1102	1234	1264
78"	501	486	498	507	514	583	595	611	626	687	712	731	750	840	881	911	1057	1089	1130	1264	1298
84"	511	496	505	514	525	594	608	623	634	704	731	749	765	855	899	931	1081	1121	1161	1295	1331
90"	517	502	511	522	533	604	622	631	649	712	741	761	777	878	916	956	1102	1144	1187	1329	1368
96"	522	507	514	526	538	615	628	645	660	728	757	774	799	891	934	977	1130	1167	1218	1360	1397
102"	526	511	525	534	550	622	636	655	671	740	772	789	814	911	956	999	1154	1197	1244	1390	1437
108"	533	518	530	543	558	628	649	664	683	753	782	807	831	927	977	1022	1181	1223	1275	1421	1470
114"	541	525	534	554	566	636	657	677	699	765	802	823	849	945	995	1043	1202	1247	1307	1466	1526
120"	542	526	543	560	575	649	664	689	709	777	814	834	862	965	1020	1064	1228	1280	1331	1481	1531
126"	549	533	554	571	581	657	680	700	717	786	827	854	881	980	1036	1086	1252	1305	1356	1508	1558

### 1" SLATS .008 GAUGE

HEIGHT UP TO	WIDTH UP TO →																				
	12"	23"	26"	29"	32"	36"	40"	44"	48"	52"	57"	62"	67"	72"	82"	92"	102"	112"	122"	132"	142"
42"	\$473	458	461	468	478	536	548	560	567	626	643	652	667	752	778	801	935	958	983	1112	1129
48"	476	461	468	480	486	551	560	570	578	641	661	672	684	772	801	829	960	983	1016	1144	1169
54"	483	468	480	486	490	560	570	578	591	649	676	692	704	794	821	853	987	1016	1046	1177	1207
60"	496	480	486	490	507	570	578	592	601	667	692	706	722	810	843	872	1016	1046	1077	1211	1239
66"	498	482	490	507	517	578	592	601	616	683	706	722	735	831	864	894	1043	1073	1112	1247	1281
72"	502	487	500	514	521	591	601	616	632	696	722	737	757	853	886	923	1069	1106	1146	1281	1315
78"	513	498	510	519	527	600	612	628	645	709	735	757	777	868	913	945	1098	1133	1178	1315	1353
84"	522	507	517	527	540	611	626	643	656	725	757	776	793	886	934	969	1123	1166	1211	1349	1388
90"	529	514	525	536	550	622	641	653	672	735	768	788	807	911	952	997	1146	1193	1240	1386	1429
96"	534	519	527	542	554	632	648	668	683	753	784	804	831	926	972	1020	1178	1219	1275	1420	1462
102"	541	525	540	551	566	641	659	676	695	766	801	821	847	945	997	1043	1204	1252	1304	1454	1506
108"	547	531	547	560	575	648	672	687	709	781	814	838	867	965	1020	1069	1234	1280	1336	1489	1542
114"	555	540	551	571	583	659	679	704	725	793	834	859	885	984	1037	1092	1256	1307	1372	1538	1603
120"	557	542	560	578	595	672	687	716	736	807	847	870	899	1005	1065	1114	1285	1343	1397	1554	1609
126"	565	550	571	591	603	679	706	726	746	818	863	891	922	1022	1084	1140	1312	1369	1425	1583	1636

Template Service Fee (see page 18 for explanation): \$25 (net price)

## COLORS

Alabaster . . . . . 112	Forest Shadow . . . . . 087	Real Red . . . . . 085	<b>PREMIUM COLORS (10% Surcharge)</b>
Almond . . . . . 724	Granite . . . . . 044	Rock Gray . . . . . 399	
Almost White Gloss . . . 065	Gray Dawn . . . . . 405	Silver . . . . . 737	
Aluminum . . . . . 034	Gray Haze . . . . . 983	Skyline . . . . . 680	
Beige . . . . . 011	Greige . . . . . 122	Smokey Gray . . . . . 026	
Birch White . . . . . 375	Hunter Green . . . . . 154	Snowcap White . . . . . 386	
Black Satin . . . . . 233	Ice . . . . . 778	Stucco . . . . . 963	
Buff . . . . . 624	Lamplight . . . . . 904	Tender Taupe . . . . . 103	
Burgundy . . . . . 653	Magnet . . . . . 648	True Blue . . . . . 089	
Cameo . . . . . 607	Matte White . . . . . 042	True White . . . . . 544	
Char Brown . . . . . 062	Mercury . . . . . 771	U.N. Gray . . . . . 095	
Coconut . . . . . 630	Midnight Blue . . . . . 057	Vanilla . . . . . 100	
Creamy Beige . . . . . 670	Milk Chocolate . . . . . 060	White Gloss . . . . . 005	
Crystal White . . . . . 629	Navajo White . . . . . 376	White Satin . . . . . 205	
Desert Sand . . . . . 625	Parchment . . . . . 535		
Fawn . . . . . 031	Pitch Black . . . . . 033		
Flax . . . . . 541	Raw Umber . . . . . 006		

## Options Pricing

## OPTIONS PRICING

OPTIONS	SURCHARGE
Cloth tapes (2" Grandeur™ only)	See Price Charts
Bay and Corner Window	No charge
Cut-outs	\$66
Double Slat	Double blind price
Hidden Holes	See surcharges with Price Charts
Hold-down Brackets	No charge
Inverted Slats	\$13
Limited Tilt	No charge
Motorization	See Motorization tab for pricing information
Multi-colored Striped Blinds	Second color: \$23 All additional colors: \$8 Each additional blind of the same size and pattern on the same order: \$8
Multiple Blinds on one Headrail	See Price Charts
Premium Blind Colors	10% surcharge (add to base price)
Projection Brackets: 1¾", 2¾" 4¾"	No charge
Ring Pull/Ring Tilt	No charge
Shims (⅞")	No charge
Sky Poles	3-6½ ft: \$44, 5-9½ ft: \$67
Template Service	\$25 (net price)
Top Lock	No charge
Wood Cornices and Wood Valances	See Cornice and Valances Price List for pricing information



Graber is a brand of Springs Window Fashions, the Best Experience Company 

[graberblinds.com](http://graberblinds.com)