



**GRABER** | DELIGHT IN  
EVERY DETAIL

## **Graber Cellular Shades English/US Price Guide**

# CELLULAR SHADES

## Product Information Guide

### Features

Fabric Styles and Information: Cellular Shades, Light Control and Privacy, Fabric Certifications . . . . .	2
Summary . . . . .	3

### Control Type and Size Considerations

Cordless Lift, Bottom Up/Top Down Cordless Lift . . . . .	4
Sun Up/Sun Down Cordless Lift, Perfect-Vue™ Cordless Lift . . . . .	5
Continuous-Loop Lift . . . . .	6
Top Down Continuous-Loop Lift, Motorized Lift . . . . .	7
Multiple Shades on One Headrail: Cordless Lift, Continuous-Loop Lift . . . . .	8
Perfect-Vue™ Cordless Lift . . . . .	9
Slide-Vue™ Shades . . . . .	10

### Options

Enhanced Light Control Features, Fabric Wrapped Rails . . . . .	11
Corner Windows . . . . .	12
Bay Windows . . . . .	13
SkyTrack™ Skylight . . . . .	14
Specialty Shapes: Arch Shades . . . . .	15
Specialty Shapes: Octagon and Hexagon, Trapezoids, Angle Top/Angle Bottom . . . . .	16
Making a Template for Specialty Windows, Using Template Service . . . . .	17

### General Information

Energy Performance, Energy Efficiency Ratings . . . . .	18
Stack Height Chart . . . . .	19
Stack Height Chart: Perfect-Vue™ . . . . .	20
Stack Width Chart Slide-Vue™ . . . . .	21
Cellular Shade Color Coordination Chart . . . . .	22-25
Cordless Lift Product Detail . . . . .	26
Continuous-Loop Lift Product Detail . . . . .	27
Bottom Up/Top Down Cordless Lift Product Detail . . . . .	28
Cordless Lift Product Detail Perfect-Vue™ . . . . .	29
Slide-Vue™ Product Detail . . . . .	30

## PLEASE NOTE:

Photos and illustrations are for inspiration only.  
Not all product configurations are available in all countries.

Window blinds with a damaged or loose tension device or retractable cord that fails to fully retract pose a strangulation risk to children. To avoid this potential strangulation risk, consider purchasing cordless products or products with inaccessible cords.

# GRABER®

MAY 2024

(5/24) 23-513400

# Features

Graber® Cellular Shades are made from a variety of luxurious spunlace and woven fabrics. These shades are highly insulating due to the pockets of air formed by the cellular design. Graber CrystalPleat Cellular Shades are the perfect combination of function and fashion, providing energy efficiency while stylishly covering your windows.

- Highly insulating
- Solutions for numerous privacy and light control needs
- Offered in four cell sizes to match diverse decor styles
- Broad spectrum of on-trend colors, patterns, and textures to enhance every room
- All shade components are color coordinated

## Fabric Styles and Information: Cellular Shades

Fabric Styles	Cell Size	Level of Light Control/ Privacy	Fabric Content	Greenguard Certified	Anti-microbial	FR Rated
Champagne Toast	¾" Single Cell 1¼" Single Cell	Sheer	100% polyester woven			
Couture	¾" Single Cell	Semi-sheer Blackout	100% polyester woven paired with 100% polyester spunlace 100% polyester woven paired with a concealed blackout liner			
Discovery	⅝" Single Cell ¾" Single Cell	Blackout	100% polyester spunlace with metallic blackout liner			
Enchantment	¾" Single Cell	Light filtering Blackout	100% polyester spunlace 100% polyester spunlace metallic blackout liner			
Endeavor	⅝" Single Cell ¾" Single Cell	Light filtering	100% polyester spunlace			
Infuse	¾" Single Cell	Light Filtering Blackout	100% polyester spunlace 100% polyester spunlace with metallic blackout liner		•	
Kinsley	¾" Single Cell	Semi-sheer Blackout	100% polyester woven paired with 100% polyester spunlace 100% polyester woven paired with a concealed blackout liner			
Montage	¾" Single Cell	Light filtering Blackout	100% polyester spunlace 100% polyester spunlace metallic blackout liner			
Prestige	¾" Single Cell	Light filtering Blackout	100% polyester spunlace 100% polyester spunlace metallic blackout liner			
Sanctuary	½" Double Cell ¾" Single Cell 1¼" Single Cell	Blackout	100% polyester spunlace with concealed blackout liner	•		
Scroll FR	¾" Single Cell	Light filtering	100% polyester spunlace			•
Simply Sheer	¾" Single Cell	Sheer	100% polyester woven			
Splendor	½" Double Cell ¾" Single Cell 1¼" Single Cell	Light filtering	100% polyester spunlace	•		
Valletta	¾" Single Cell 1¼" Single Cell	Light filtering Blackout	100% polyester woven 100% polyester woven paired with a concealed blackout liner			

## Light Control and Privacy

**Sheer:** Allows the most sunlight and the least privacy.

**Semi-Sheer\*:** Allows moderate sunlight and a little privacy.

**Light Filtering (LF)\*:** Blocks some sunlight and offers some privacy.

**Blackout (BO):** Blocks all sunlight and offers complete privacy.

\*These fabrics allow some light to come through, so their colors may be influenced by changing light conditions. Colors may appear to vary depending upon the time of day and type of lighting, as well as whether the shade is partially or fully lowered.

## Fabric Certifications

GREENGUARD Indoor Air Quality Certified® Fabrics: Many Graber® fabrics have been certified by GREENGUARD Environment Institute (GEI) to be low chemical- and particle-emitting fabrics, which provides a healthier indoor air quality. The process used for certification complied with established indoor air quality standards and is performed by a third party lab.



# Features

## Summary (for surcharges and pricing refer to price charts)

The following is a list of options for cellular shades.

**Control Type Options** (see price charts for pricing and/or surcharges)

- Continuous-loop lift (US only)
- Cordless lift
- Motorized lift (see motorization product information guide)
- Slide-View™ (US only)

**Shade Options—No Charge**

- Cord loop placement on right or left
- Corner or bay window
- Hold down brackets
- Lightblocking strip available with cordless lift, continuous-loop lift, and motorized lift shades
- Projection brackets:
  - For all cordless lift, continuous-loop lift, and motorized lift shades:
    - Long (adds up to 2<sup>3</sup>/<sub>8</sub>" extension from wall)
    - Medium (adds up to 1<sup>1</sup>/<sub>2</sub>" extension from wall)
    - Short (adds up to <sup>7</sup>/<sub>8</sub>" extension from wall)
  - For Slide-View (US only):
    - Long (adds up to 2<sup>1</sup>/<sub>4</sub>" extension from wall)
    - Medium (adds up to 1<sup>1</sup>/<sub>4</sub>" extension from wall)
    - Short (adds up to <sup>3</sup>/<sub>4</sub>" extension from wall)
- Rail color can be specified at the time of order
- Shims
- Side-mount brackets: inside mount only
- Fabric can be reversed at the time of order
- Custom cord loop length is available upon request at time of order (US only)

**Specialty Shape Shade Options** (see price charts for pricing and/or surcharges)

- Angled top/angled bottom (US only)
- Non-Perfect Arches
- Octagon, hexagon, or trapezoid (US only)
- Perfect Arches

**Shade Options—Surcharge** (see price charts for pricing and/or surcharges)

- Room-darkening side channels (<sup>3</sup>/<sub>4</sub>" single cell and <sup>1</sup>/<sub>2</sub>" double cell with cordless lift and motorized controls)
- Bottom up/top down: cordless lift (US only)
- Fabric Wrapped Rails (cordless lift, continuous-loop lift, and motorized lift shades)
- Multiple shades on one headrail
- Sky pole
- Perfect-View™ shade: cordless lift (US only)
- Skylight shades (US only)
- Sun up/sun down: cordless lift
- Top down only: continuous-loop lift (US only)
- Wood cornice (see cornices and valances product information guide)

### Control Type

Cell Size	Cordless Lift	Continuous-Loop Lift	Motorized Lift	Slide-View	Bottom Up/Top Down	Sun Up/Sun Down	Perfect-View	Specialty Shapes	Skylights	Side Channels
<sup>1</sup> / <sub>16</sub> " Single Cell	•	•	•		•	•	•	•		
<sup>3</sup> / <sub>4</sub> " Single Cell	•	•	•	•	•	•	•	•	•	•
<sup>1</sup> / <sub>2</sub> " Double Cell	•	•	•	•	•	•	•	•	•	•
1 <sup>1</sup> / <sub>4</sub> " Single Cell	•		•	•	•					

## Control Type and Size Considerations

### Cordless Lift

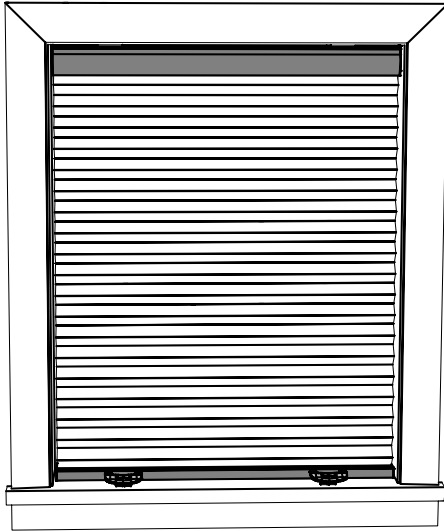

- Applies to standard, bottom up/top down, sun up/sun down, and Perfect-Vue™ shades
  - Safest window shade; ideal for homes with children or pets
  - Side mounts available up to 60" wide
  - An optional sky pole is available for hard to reach shades 24" or less in width; if a skypole is required for shades over 24" in width, two skypoles are recommended to ensure even operation
  - Room-darkening side channels are available:
    - Surcharge (see price charts)
    - ¾" single cell and ½" double cell only
    - Side channels are Canyon Gray 053, Cream 715, Creamy Pearl 356, Revere Pewter 190, Sable 565, Smokey Gray 026, or White Satin 205
- NOTE:** All cordless lift shades should be used on windows where the consumer can comfortably raise and lower the shade with their hand and have easy access.

Size Considerations	Minimum Width* (inches)	Maximum Width (inches)	Minimum Height (inches)	Maximum Height (inches)
Cordless Lift	9	120	9	86
Bottom Up/Top Down Cordless Lift	15	120	9	86
Sun Up/Sun Down Cordless Lift	15	96	12	86
Perfect-Vue Cordless Lift†	15	94	12	86

\*For all inside mount applications, ⅜" deduction is taken by manufacturer on overall width.

†Minimums and maximums vary slightly by cell size. Maximum shade width is based on fabric width. See Perfect-Vue size considerations for details.

**NOTE:** Maximum area for Sanctuary ½" double cell is 7,200 square inches, 6,400 square inches with Perfect-Vue.

### Bottom Up/Top Down Cordless Lift

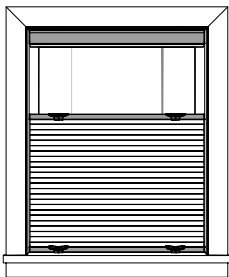

- Option allows for privacy, yet lets natural light shine in

Fabric Style	Minimum Width* (inches)	Maximum Width (inches)	Minimum Height (inches)	Maximum Height (inches)
½" Double Cell Sanctuary	15	96	9	86
⅜" Single Cell Discovery				
¾" Single Cell Champagne Toast, Couture LF & BO, Enchantment BO, Infuse BO, Kinsley LF & BO, Montage BO, Prestige BO, Sanctuary, Scroll FR, Valletta BO	15	108	9	86
1¼" Single Cell Champagne Toast, Sanctuary, Valletta LF, Valletta BO				
⅜" Single Cell Endeavor				
½" Double Cell Splendor				
¾" Single Cell Discovery, Enchantment LF, Endeavor, Infuse LF, Montage LF, Prestige LF, Simply Sheer, Splendor LF, Valletta LF	15	120	9	86
1¼" Single Cell Splendor				

## Control Type and Size Considerations

### Sun Up/Sun Down Cordless Lift

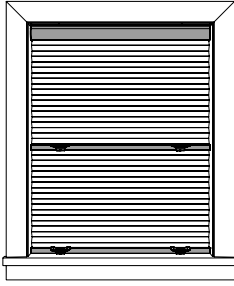

- Perfect for combining light controls of sheer, semi-sheer, or light-filtering and blackout
- $\frac{9}{16}$ " single cell fabrics can only be combined with  $\frac{9}{16}$ " single cell fabrics
- $\frac{3}{4}$ " single cell fabrics can only be combined with  $\frac{1}{2}$ " double cell or  $\frac{3}{4}$ " single cell fabrics
- $\frac{1}{2}$ " double cell can only be a bottom fabric; two  $\frac{1}{2}$ " double cell fabrics cannot be combined
- Headrail, midrail, and bottomrail are color coordinated; headrail and midrail match top fabric and bottomrail matches bottom fabric
- $1\frac{1}{4}$ " single cell is not available in sun up/sun down

### Perfect-Vue™ Cordless Lift

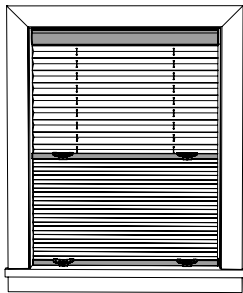

- Perfect for combining light controls of sheer and light-filtering pleated fabric with blackout cellular fabrics
- 1" pleated can be combined with  $\frac{9}{16}$ " single cell cellular fabrics only
- 2" pleated can be combined with  $\frac{3}{4}$ " single cell and  $\frac{1}{2}$ " double cell cellular fabric only
- Headrail, midrail, and bottomrail are color coordinated; headrail and midrail match top fabric and bottomrail matches bottom fabric
- $1\frac{1}{4}$ " single cell is not available in Perfect-Vue shades

### Depth Requirements for Inside Mount: Cordless Lift and Perfect-Vue Cordless Lift

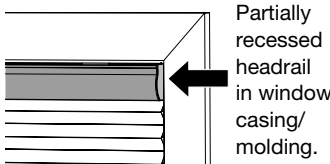
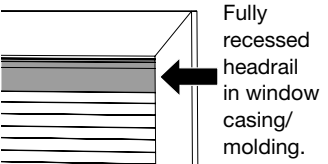
Shade Type	Cell Size	Cordless Lift Headrail Dimensions (inches)	 Partially recessed headrail in window casing/ molding.		 Fully recessed headrail in window casing/ molding.	
			Minimum Depth Mount (inches)	Flush with Casing (inches)		
Cordless Lift*	1 $\frac{1}{4}$ " Single Cell	1 $\frac{5}{8}$ x 3 $\frac{3}{16}$	1 $\frac{5}{8}$	3 $\frac{3}{8}$		
	$\frac{1}{2}$ " Double Cell	1 $\frac{9}{16}$ x 2 $\frac{3}{8}$	$\frac{5}{8}$	2 $\frac{5}{8}$		
	$\frac{3}{4}$ " Single Cell	1 $\frac{9}{16}$ x 2 $\frac{1}{2}$	$\frac{5}{8}$	2 $\frac{3}{8}$		
Perfect-Vue Cordless Lift	1" Pleat	1 $\frac{9}{16}$ x 2 $\frac{1}{8}$	$\frac{5}{8}$	2 $\frac{3}{8}$		
	2" Pleat	1 $\frac{9}{16}$ x 2 $\frac{3}{8}$	$\frac{5}{8}$	2 $\frac{3}{8}$		

\*The depth requirements for cordless lift shades also apply to motorized.

# Control Type and Size Considerations

## Continuous-Loop Lift

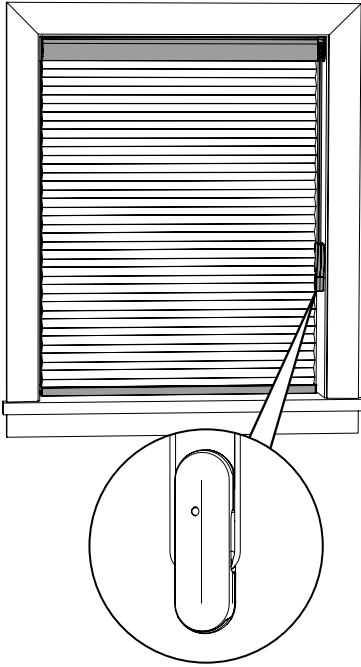

- For surcharges, see price charts
- Recommended for larger, heavier shades
- A single continuous-loop cord raises and lowers the shade and keeps the cord the same length
- 1¼" single cell fabrics not available with continuous-loop lift
- Four colors of continuous-loop cord available
- A cord hold down device is included with all continuous loop lift systems; the device must be properly installed to safely control the cord loop
- For inside mount, install the shade in the back of the window frame so the cord tensioner can be mounted in front of the shade and not interfere with shade operation. Additional mounting depth may be required.
- Larger shades use a larger clutch ratio for easier lifting, but additional pulls are required to raise the shade

Size Considerations	Minimum Width* (inches)	Maximum Width*** (inches)	Minimum Height (inches)	Maximum Height***† (inches)
Continuous-Loop Lift	18½	144	9	144
Top Down Only Continuous-Loop Lift	18½	72	12	96

\*For all inside mount applications, ⅜" deduction is taken by manufacturer on overall width.

\*\*See continuous-loop lift control area limit chart for SIZE RESTRICTIONS by fabric type.

† Maximum shade size of 144" x 144" achievable by ordering multiple shades on one headrail.

Finished Shade Height (inches)	Continuous-Loop Cord Length (inches)
12 to 26	18
26⅙ to 38	24
38⅙ to 50	36
50⅙ to 62	48
62⅙ to 74	60
74⅙ to 96	72
96⅙ to 120	84
120⅙ to 130	96
130⅙ to 144	108

Control length for continuous-loop lift shades varies based on finished shade height (above). Optional cord loop length can be specified at the time of order.

Continuous-Loop Lift Area Limit Chart	
Fabric Style	Maximum Shade Size (square inches)
½" Double Cell Sanctuary	9,000
⅝" Single Cell Discovery ¾" Single Cell Champagne Toast, Couture LF & BO, Enchantment BO, Infuse BO, Kinsley LF & BO, Montage BO, Prestige BO, Sanctuary, Scroll FR, Valletta BO	11,000
½" Double Cell Sanctuary ¾" Single Cell Infuse LF, Valletta LF	13,000
⅝" Single Cell Endeavor ¾" Single Cell Enchantment LF, Montage LF, Prestige LF	17,000
¾" Single Cell Discovery, Endeavor, Simply Sheer, Splendor	20,800*

\*Available up to 144" width x 144" height.

Loop Cord Colors	
Smokey Gray	026
Tender Taupe	103
Vanilla	100
White	00

Tension Device Colors	
Clear	00
White	871
Cream	715

# Control Type and Size Considerations

## Top Down Continuous-Loop Lift

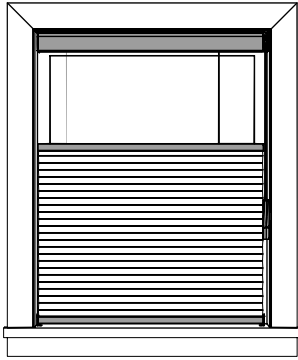

- Top down only operates with the continuous-loop lift
- Bottomrail must be mounted

**NOTE:** Top down only shades that exceed the maximum width may be made as multiple shades on one headrail. However, an additional surcharge will be added if the total ordered width is less than or equal to the maximum fabric width.

## Depth Requirements for Inside Mount: Continuous-Loop Lift

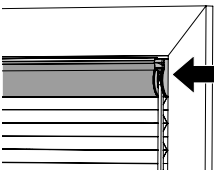
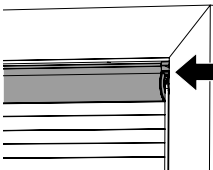
Shade Type	Cell Size	Continuous-Loop Lift Headrail Dimensions (inches)	 Partially recessed headrail in window casing/molding.	 Fully recessed headrail in window casing/molding.
			Minimum Depth Mount (inches)	Flush with Casing (inches)
Continuous-Loop Lift	3/4" Single Cell 1/2" Double Cell	1 1/16 x 2 3/8	5/8	2 3/8
	9/16" Single Cell	1 1/16 x 2 3/8	5/8	2 3/8

## Motorized Lift



- **Refer to motorization product information guide for additional options, sizing, and pricing**
- Window treatments can be operated from virtually anywhere in the home
- Provides easy operation of hard-to-reach or large window coverings
- Efficiently manages energy (heat gain and loss)
- Operate multiple window treatments simultaneously or individually
- A safer lift option alternative; ideal for homes with children and pets
- Easily integrated with home automation systems
- Low voltage motorization requires no costly electrical hardwiring
- Multiple control and power options available, see motorization product information guide for options
- Boost room-darkening performance by reducing light leakage between the window and headrail by adding a lightblocking strip at no additional surcharge

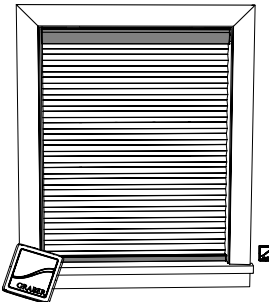

**NOTE:** Motorization components and accessories have a five-year limited warranty, excluding batteries.



## Control Type and Size Considerations

### Multiple Shades on One Headrail: Cordless Lift

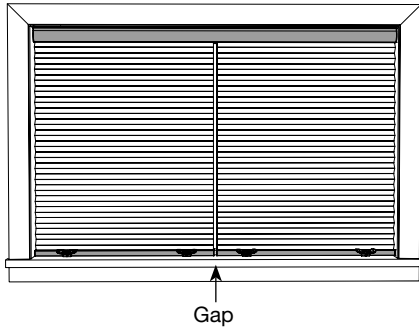

- Cordless lift available as two or three shades on one headrail
- Side mount brackets available on shades 60" or smaller

Size Considerations	Maximum Overall Size For Multiple Shades* (inches)	Maximum Size with Side Mount (inches)	Control Locations	Gap (inches)
Cordless Lift	144 x 86	60 x 86	Not applicable	3/8

\*See size considerations section for the minimum and maximum panel widths.

### Multiple Shades on One Headrail: Continuous-Loop Lift

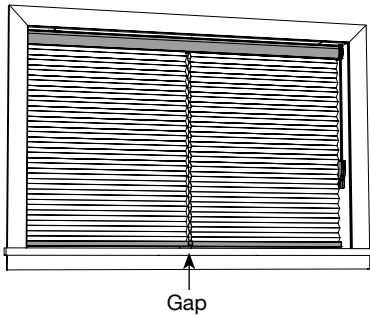

- Available as two or three shades on one headrail
- Side mount brackets available on shades 60" or smaller
- With multiple shades on one headrail, area limits are based on the sum of all shade panels on a control
- See continuous-loop area limit chart for maximum area limits

Size Considerations	Maximum Overall Size For Multiple Shades* (inches)	Maximum Size with Side Mount (inches)	Control Locations	Gap (inches)
Continuous-Loop Lift Single Control Shade	120 x 144	60 x 96	Two-on-one: Common lift cord can be on right or left to operate both shades at the same time Three-on-one: Common lift cord can be on right or left to operate all shades at the same time	1/2
Continuous-Loop Lift Multi Control Shade	144 x 144	60 x 96	Two-on-one: Left shade, left control Right shade, right control Three-on-one: Left shade, left control Right shade, right control Middle shade, common lift cord to right or left blind Continuous-loop lift cannot be used in the middle of the headrail on multiple shades	1/2
Continuous-Loop Lift Top Down Only- Single Control Shade	120 x 96	NA	Two-on-one: Common lift cord can be on right or left to operate both shades at the same time Three-on-one: Common lift cord can be on right or left to operate all shades at the same time	1/2
Continuous-Loop Lift Top Down Only- Multi Control Shade	144 x 96	NA	Two-on-one: Left shade, left control Right shade, right control Three-on-one: Left shade, left control Right shade, right control Middle shade, common lift cord to right or left blind Continuous-loop lift cannot be used in the middle of the headrail on multiple shades	1/2

\*See size considerations section for the minimum and maximum panel widths.

## Control Type and Size Considerations

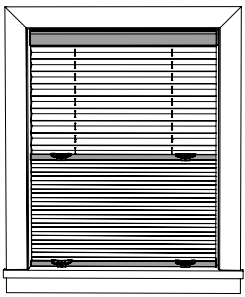
Perfect-Vue™ Cordless Lift				
				
	<b>Cordless Lift All Cellular Fabric Styles</b>			
	<b>Width</b>		<b>Height</b>	
<b>Fabric Styles</b>	<b>Minimum† (inches)</b>	<b>Maximum (inches)</b>	<b>Minimum (inches)</b>	<b>Maximum (inches)</b>
<b>1" FashionPleat®</b>				
Allure Sheer Linen	15	72	12	86
Desert	15	94	12	86
<b>1" EvenPleat®</b>				
Allure Sheer Linen	15	72	12	86
Aberdeen Inkblot Serendipity Spring Bloom	15	92	12	86
Debonair Desert Sahara Ridge Terrain	15	94	12	86
<b>2" EvenPleat</b>				
Grasscloth Sheer Linen	15	72	12	86
Aberdeen Canyon Ridge Serendipity	15	92	12	86
Cloud Metal Debonair Desert Marina Prescott Sahara Ridge Terrain	15	94	12	86

†For all inside mount applications, 3/8" deduction is taken by manufacturer on overall width.

Maximum area for Sanctuary 1/2" double cell is 6,400 square inches.

Maximum area for 1" Aberdeen, Debonair, Sahara Ridge and Terrain is 6400 square inches; 2" Debonair and Prescott is 5800 square inches, 2" Marina and Sahara Ridge is 7000 square inches, 2" Aberdeen, Cloud Metal and Terrain is 7600 square inches

## Control Type and Size Considerations

### Slide-Vue™ Shades

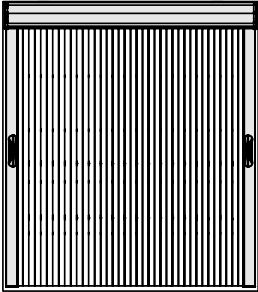
				
	<b>Slide-Vue All Fabric Styles</b>			
	<b>Width</b>		<b>Height</b>	
<b>Fabric Styles</b>	<b>Minimum (inches)</b>	<b>Maximum (inches)</b>	<b>Minimum (inches)</b>	<b>Maximum (inches)</b>
All Fabric Styles	12	192	24	120

**NOTE:** Not available for 1/16" single cell.

### Depth Requirements for Inside Mount: Slide-Vue Shades

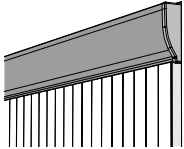
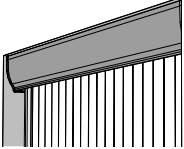
			 <p style="text-align: center;">Partially recessed headrail in window casing/ molding</p>	 <p style="text-align: center;">Fully recessed headrail in window casing/ molding</p>
	<b>Cell Size (inches)</b>	<b>Headrail Dimensions (inches)</b>	<b>Minimum Depth Mount (inches)</b>	<b>Flush with Casing (inches)</b>
Slide-Vue Shades	1¼ Single Cell	2 <sup>7</sup> / <sub>16</sub> x 3 <sup>7</sup> / <sub>16</sub>	1 <sup>1</sup> / <sub>8</sub>	3 <sup>1</sup> / <sub>16</sub>
	½ Double Cell	2 <sup>7</sup> / <sub>16</sub> x 3	1 <sup>1</sup> / <sub>8</sub>	3 <sup>3</sup> / <sub>16</sub>
	¾ Single Cell	2 <sup>7</sup> / <sub>16</sub> x 3	1 <sup>1</sup> / <sub>8</sub>	3 <sup>5</sup> / <sub>16</sub>

# Options

## Enhanced Light Control Features

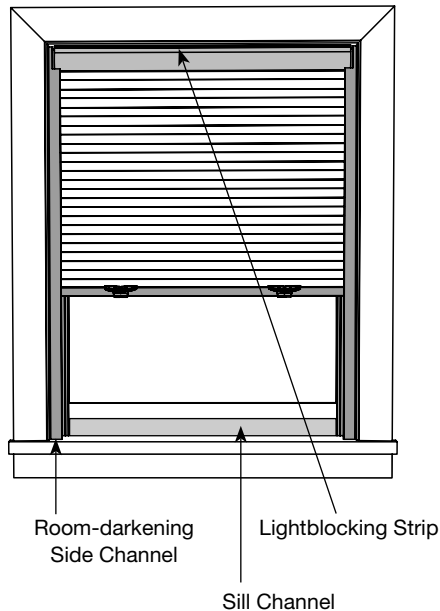

### Lightblocking Strip

- Boost room-darkening performance by reducing light leakage between the window and headrail
- Ideal option for bedrooms, nurseries, and those who prefer blackout light control
- Available for cellular shades with cordless lift, continuous-loop lift, and motorized lift

### Room-Darkening Side Channels

- **For surcharge, see price charts**
- Side channels boost room-darkening performance by reducing light leakage at sides of shades between the fabric and window frame
- Sill channel boosts room darkening performance by reducing light leakage between the bottomrail and sill
- Maximizes privacy
- Aluminum side channel now comes with a black PVC insert to absorb light and reflect light back outside.
- Ideal option for bedrooms, nurseries, and those who prefer enhanced light control
- Available for 3/4" single cell and 1/2" double cell cellular shades with cordless lift and motorized controls
- Maximum width and height is 120"x120"
- Rail colors are: Canyon Gray 053, Cream 715, Creamy Pearl 356, Revere Pewter 190, Sable 565, Smokey Gray 026, or White Satin 205, refer to "Cellular Shade Color Coordination Chart" for more information
- Room-darkening side channels can increase energy efficiency. Shades with room-darkening side channels can reduce heat transfer by up to 33% during the winter and up to 74% during the summer.

Window and window covering											
			Without Side Channels				With Side Channels				
			R-Value		SHGC		R-Value		SHGC		
	Cell Size	Style	R Value	% Reduction of heat transfer	SHGC	% Reduction of heat transfer	R Value	% Reduction of heat transfer	SHGC	% Reduction of heat transfer	
Db1 Pane Low E	3/4" SC	Sanctuary	4.55	18%	0.10	64%	5.00	23%	0.11	62%	
Db1 Pane Low E	1/2" DC	Splendor	4.55	20%	0.11	62%	5.00	24%	0.12	60%	
Db1 Pane Low E	1/2" DC	Sanctuary	4.76	22%	0.12	60%	5.00	26%	0.10	64%	
Db1 Pane Low E	3/4" SC	Splendor	4.55	19%	0.13	54%	4.76	22%	0.13	55%	
Db1 Pane Clear	3/4" SC	Sanctuary	2.78	24%	0.21	69%	3.13	32%	0.19	72%	
Db1 Pane Clear	1/2" DC	Splendor	2.86	25%	0.24	65%	3.13	32%	0.23	67%	
Db1 Pane Clear	3/4" SC	Splendor	2.78	23%	0.29	57%	2.94	29%	0.28	59%	
Db1 Pane Clear	1/2" DC	Sanctuary	2.86	26%	0.2	70%	3.13	33%	0.18	74%	

## Fabric Wrapped Rails

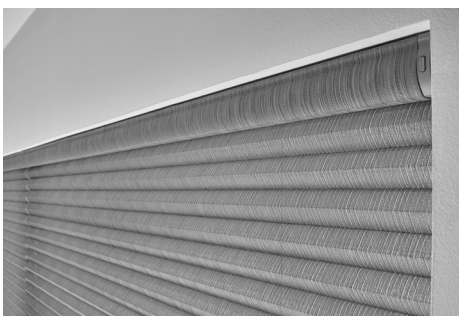

- Perfect coordinate rails and fabric for a seamless, designer look
- Available in Splendor, Sanctuary, and Champagne Toast styles
- Available in cordless, continuous-loop, and motorized
- Minimum width is 12"

# Options

## Corner Windows

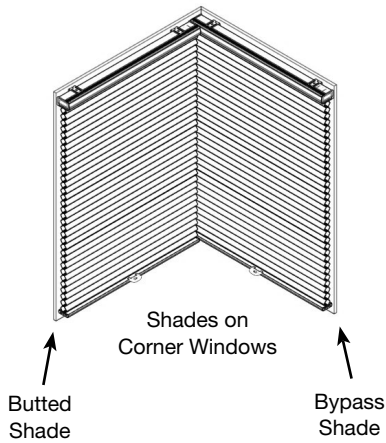

- **No charge**
- Made as individual shades
- Each shade will have its own control; we recommend opposite corners
- Indicate for each shade whether left or right and butt or bypass
- Bypass shade is mounted into the corner; butt shade is abutted to the other shade
- Manufacturer will take appropriate deductions for proper fit; **DO NOT** order as a corner shade if you do not want manufacturer to take deductions
- For Slide-View™ shades, the handles between the bypass and butt shades will be offset 3/4" from each other for ease of operation

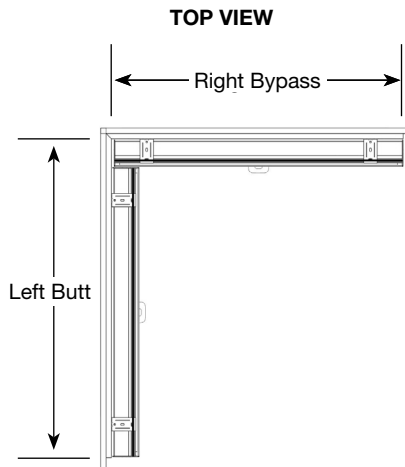

### Measuring Information

#### Mounting on a Wall or Molding:

Measure the width of each window from the corner on the mounting surface (molding or wall) to the point you would like to cover.

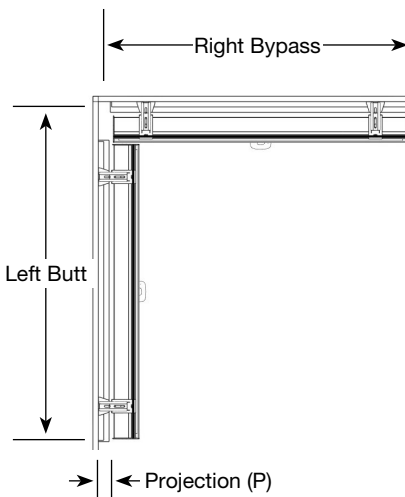

#### Mounting Above the Molding:

Measure the width of each window from the corner on the mounting surface to the point you would like to cover.

Projection measurement is the distance needed to clear any molding or obstructions that the shade will be mounted above.

**NOTE:** The projection (P) distance is needed to correctly calculate deductions for installations where the shades will use shims or projection brackets to clear molding. All projection distances must match for correct deductions to be calculated.

# Options

## Bay Windows

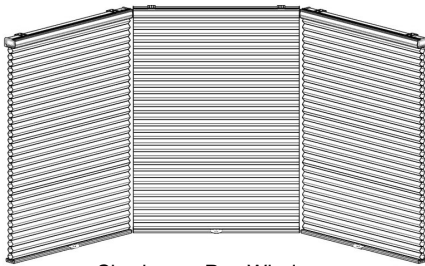

Shades on Bay Windows

- **No charge**
- Made as individual shades
- Each section will have its own control
- Manufacturer will take appropriate deductions for proper fit; **DO NOT** order as a corner shade if you do not want manufacturer to take deductions
- For Slide-View™ shades there is a light gap between adjacent side rails

### Measuring Information: Three-Sided Bay Window

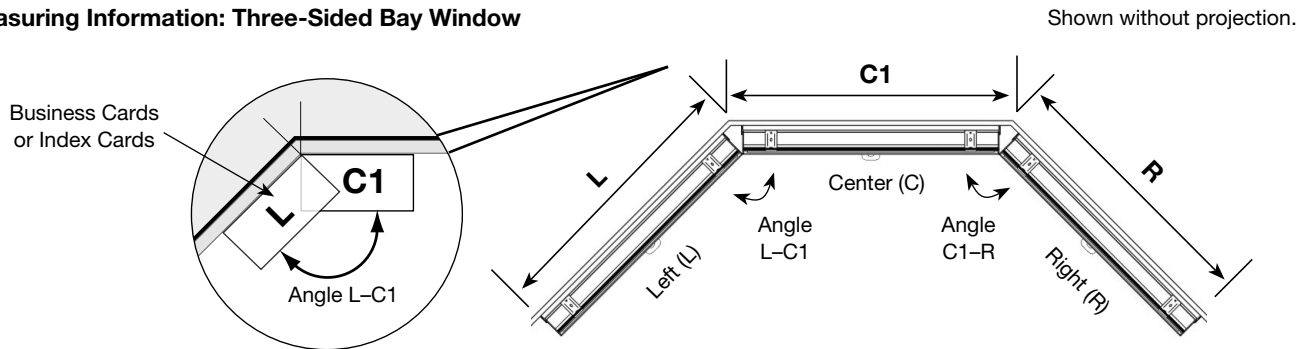

**Measure:**

**L and R:** Width of each side window from the corners on the mounting surface to the point you would like to cover.

**C1:** Width of the center window on the mounting surface from corner to corner.

**Angle L-C1:** Angle between the (L) and (C1) windows.  
**Angle C1-R:** Angle between the (C1) and (R) windows.  
**Projection:** If needed: The depth of the trim or molding the shade will be mounted above.

### Measuring Information: Four-Sided Bay Window

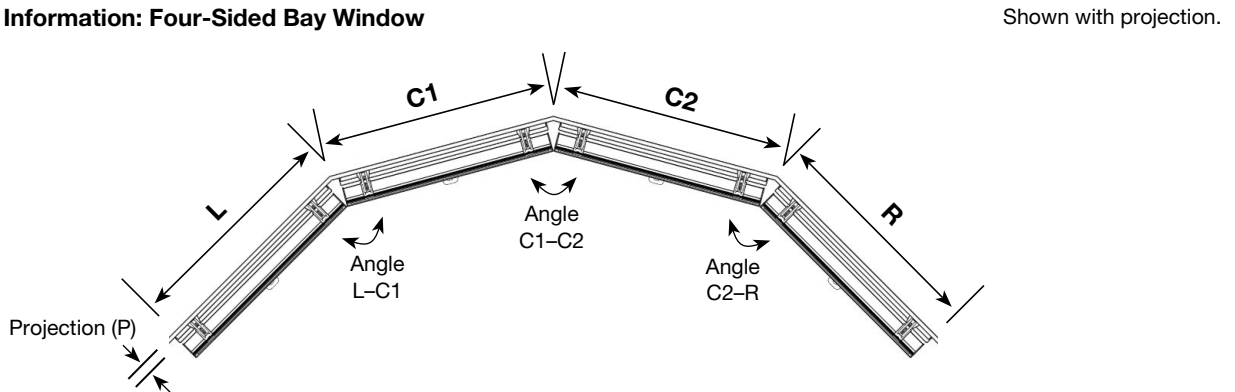

**Measure:**

**L and R:** Width of each side window from the corners on the mounting surface to the point you would like to cover.

**C1, C2:** Width of each center window on the mounting surface from corner to corner.

**Angle L-C1:** Angle between the (L) and (C1) windows.  
**Angle C1-C2:** Angle between the (C1) and (C2) windows.  
**Angle C2-R:** Angle between the (C2) and (R) windows.  
**Projection:** If needed: The depth of the trim or molding the shade will be mounted above.

**NOTE:** The projection (P) distance is needed to correctly calculate deductions for installations where the shades will use shims or projection brackets to clear trim or molding. All projection distances must match for correct deductions to be calculated. For additional windows on bays with up to five sides continue with number progression for center shade sizes (C1, C2, C3, ...) and angles (angle C1-C2, angle C2-C3, ...) as needed. Measure each bay angle using a protractor or angle finder or use two business cards in each bay corner as illustrated above and fax to customer service 1-800-552-4559.

**The angle to use between adjacent center bay windows along a straight section of wall is 180 degrees.**

## Options

### SkyTrack™ Skylight

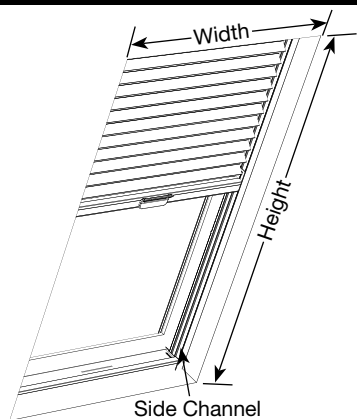

- Widths over 30¾" will have a center cord visible when the shade is open
- Operates with handle on center rail
- Brackets will be visible on an outside mount
- Skylight poles are telescoping and available upon request
- Side mounts not available
- Window top and bottom corners must be 90° (degrees)
- Available in ¾" single cell and ½" double cell
- 90° (degree) corners at top and bottom are required for mounting
- For rail color, refer to "Cellular Shade Color Coordination Chart"

Size Considerations	Minimum Recess (inches)	Flush Mount (inches)
Mounting Depth	1⅛	2½

Sky Pole  
 Sizes available: 3 to 6½ feet  
 and 5 to 9½ feet



Size Considerations	Minimum Width (inches)	Maximum Width* (inches)	Minimum Height (inches)	Maximum Height* (inches)
All Fabric Styles	12¾	61	12	61

\*For a width of 30¾" or less, maximum shade height is 96".

# Options

## Specialty Shapes: Arch Shades

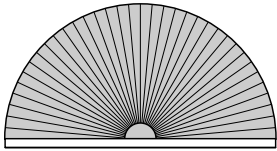

**Perfect Arch: Half Circle**

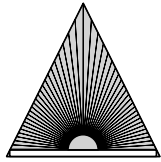

**Triangle**  
(template required)

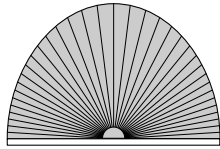

**Palladian**  
(template required)  
Illustration not to scale.

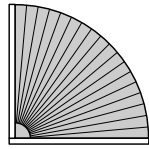

**Quarter Circle**  
(template not required if perfect quarter)

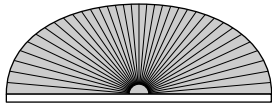

**Eyebrow Arch**  
(template required)

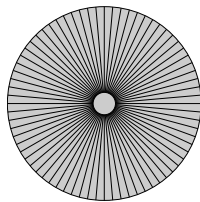

**Full Circle**  
(template not required if perfect circle)

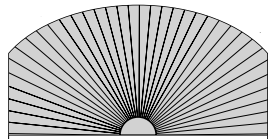

**Elongated Arch**  
(arch with straight sides)  
(template required)

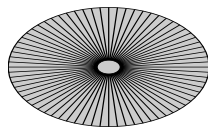

**Non-perfect Circle**  
(=oval)  
(template required)

- Not available in 1¼" single cell
- Include width and height measurements on all orders
- For inside mount, measure inside of window frame; for outside mount, add the desired amount of overlap to your measurements
- All arches are stationary
- Outside mount brackets will be visible
- Side mounts available up to 60" wide exact

**PERFECT ARCHES** are those in which the radius of the circle is constant at all points (height is exactly one-half the width).

**PERFECT QUARTER CIRCLE AND FULL CIRCLE** are those in which the width and the height are the same.

**NON-PERFECT ARCHES** are not constant at all points. Deviation of even 1/16" makes it imperfect. Non-perfect quarter circles and circles are those where the width and height are different.

- All non-perfect arches require a template

### Size Considerations

Specialty	Minimum Width* (inches)	Maximum Width (inches)	Minimum Height (inches)	Maximum Height (inches)
Half Circle	9	84	4½	50½
Palladian, Elongated, Eyebrow, and Triangle	9	84	20% of width; minimum 4½	60% of width
Quarter Circle	9	47	9	1½ times width
Full Circle	9	36 of width total	9	36

\*For all inside mount applications—3/8" deduction is taken on overall width.

Recess Depth and Flush Mount	Minimum Recess (inches)	Flush Mount (inches)
1/16" Cell Size	1 1/16	1 15/16
1/2" and 3/4" Cell Size	1 1/16	2 1/4



# Options

## Specialty Shapes: Octagon and Hexagon

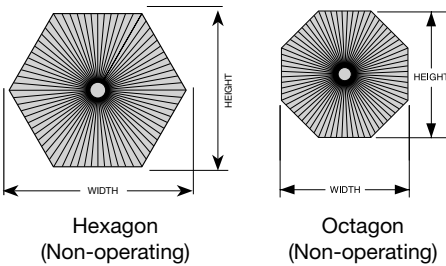

- Not available in 1¼" single cell
- Provide width and height at center of shade
- Provide side measurements as well. If side measurements are not equal, refer to Specialty Shape Measuring Guide
- Octagon and hexagon require template
- Octagon and hexagon are stationary (no controls)

	Minimum Total Width and Height (inches)	Maximum Total Width and Height (inches)
All Fabric Styles	9	36

## Specialty Shapes: Trapezoids

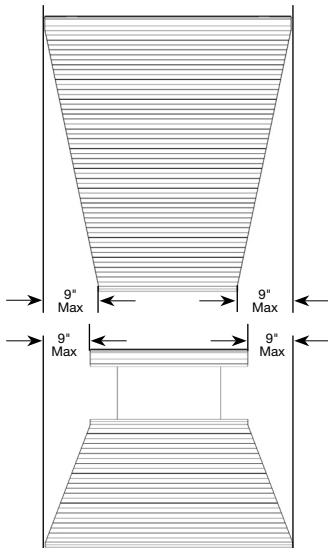

- Not available in 1¼" single cell
- Trapezoids are stationary (no controls)
- Trapezoids with one straight side are not available
- Refer to Specialty Shape Measuring Guide for all needed measurements
- Side mounts not available

	Minimum Width and Height (inches)	Maximum Width of Long Rail (inches)	Maximum Difference Between Long and Short Rails on Each Side (inches)	Maximum Height (inches)
All Fabric Styles	12	74	12	96

## Specialty Shapes: Angle Top/Angle Bottom

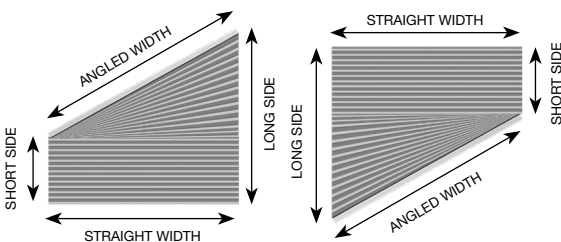

Short Side 0" to 4":

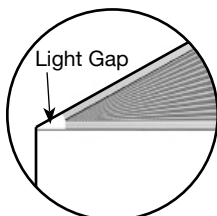

- Not available in 1¼" single cell
- Only available as non-operable
- Shades are stationary (no controls)
- Specify angle top or angle bottom when ordering
- Angle top not available with side mount
- Angle bottom is available with side mount up to 41" wide

Size Considerations	All Fabric Styles
Minimum Angled Width (inches)	12
Maximum Top Angle Width (inches)	90
Minimum Short Side of Angle (inches)	0
Maximum Bottom Angle Width (inches)	41
Minimum Long Side Height (inches)	9
Maximum Long Side Height (inches)	96
Maximum Angle Top Degree	45° (degrees): ½" double cell ¾" single cell
Maximum Angle Bottom Degree	60° (degrees): ¾" single cell 45° (degrees)

## Options

### Making a Template for Specialty Windows

1. Tape butcher paper, kraft, or construction paper over the window opening allowing plenty of overlap.
2. Being careful not to press against the template paper while tracing, draw an exact outline of the window opening. Pressing on the template paper may distort the paper and cause the wrong size to be made.
3. Remove the paper from the window opening. If the shade is an outside mount, add the desired amount of overlap to the window outline and draw a second outline around it to match the shape of the finished shade. Be sure to erase the inside line.
4. Mark the dimensions on the template. Check that the template dimensions match your measurements of the actual window opening.  
**NOTE:** Make sure the template is of the window opening, not the glass only measurement.
5. Cut the shape from the paper.
6. PLACE THE TEMPLATE BACK INTO THE WINDOW OPENING TO CHECK FOR PROPER FIT COMPLETELY AROUND.
7. Indicate on the template
  - “Room side” and “top” on the template
  - Purchase order number
  - Customer’s name
  - Your store name and account number
8. Roll up template and place in a mailing tube. DO NOT FOLD TEMPLATE.

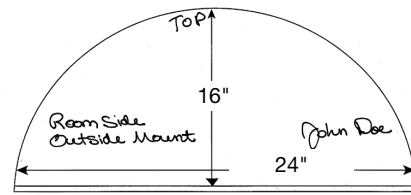

**NOTE:** This is just a sample for illustration purposes only—other information may be needed for your order.

Mail to: Springs Window Fashions, LLC  
8467 Route 405 Highway South, PO Box 500  
Montgomery, PA 17752  
ATTN: Specialty Department

**NOTE:** When mailing, make sure to get a tracking number and note your return address on the mailing tube.

#### ACCEPTABLE MATERIALS FOR MAKING TEMPLATES:

- Kraft paper
- Butcher paper
- Construction paper

#### WE WILL NOT ACCEPT TEMPLATES MADE FROM THE FOLLOWING MATERIALS:

- Newspaper
- Plastic
- Wax paper
- Fabric
- Tissue paper
- Roofing paper
- Existing arch shades
- Wrapping paper
- Cardboard
- Poster board

**NOTE:** If the material used to make a template stretches, tears easily, will not lay flat, will mark the fabric, or is not cut out from paper, IT WILL NOT BE USED.

### Using Template Service

#### For surcharge, see price charts

Template service is used when a customer is unable to make or supply a template. To use the template service, simply:

1. Select template service when entering your order online.
2. Use the template worksheet to determine what measurements you need to supply for each shape.
3. Enter the lettered measurements using line item comments. The comments have been preprogrammed to all of the measurements you need to enter for your special shape.

For additional information contact customer service.

# General Information

## Energy Performance

Graber® Cellular Shades are the smart choice for every window in your home. For year-round comfort, cellular shades effectively insulate your windows from the heat and cold. Regardless of climate, they are our most versatile and energy-saving window treatment available. Sanctuary fabric is constructed with three layers made up of a 100% metalized polyester film sealed between two layers of soft, high-quality, 100% spunlace fabric. This unique design forms a soft, thick barrier of insulation. Independent tests prove Sanctuary ½" double cell fabric is one of our most insulating fabrics on the market.\*

Add room-darkening side channels for added protection. By adding room-darkening side channels, reduce heat transfer by up to 33% during the winter and up to 74% during the summer.

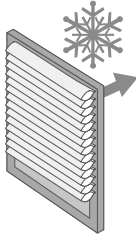

### Block the Cold

Homes in colder climates benefit from cellular shades' insulating properties to block out the cold and regulate inside temperatures.

**Reduces heat transfer by up to 26% during the winter.\***

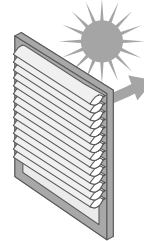

### Block the Sun

Homes in warmer climates benefit from cellular shades' lightblocking properties to keep the heat from transferring to the inside.

**Reduces heat transfer by up to 70% during the summer.\***

\*Values listed are for Sanctuary ½" double cell. Based on third-party testing, Architectural Testing Incorporated (ATI).

## Energy Efficiency Ratings

Double Pane Low-E (Double Glazing) Window and Window Covering				
Fabric Styles	R-Value (higher is better)	% Reduction of Heat Transfer	SHGC (lower is better)	% Reduction of Heat Transfer
½" Double Cell Sanctuary	4.76	22%	.12	60%
½" Double Cell Splendor	4.55	20%	0.11	62%
¾" Single Cell Discovery	4.55	21%	0.12	58%
¾" Single Cell Enchantment BO, Infuse BO, Montage BO, Prestige BO, Sanctuary	4.55	18%	.10	64%
¾" Single Cell Enchantment, Infuse LF, Montage, Prestige, Scroll FR, Splendor, Valletta LF	4.55	19%	.13	54%
¾" Single Cell Couture LF, Couture BO, Endeavor, Kinsley LF & BO, Valletta BO	4.17	13%	.15	47%
¾" Single Cell Simply Sheer, Champagne Toast	4.00	10%	0.19	30%
1 ¼" Single Cell Champagne Toast	4.00	10%	0.19	30%
9/16" Single Cell Discovery	4.55	21%	0.12	58%
9/16" Single Cell Endeavor	4.17	13%	0.15	47%
1 ¼" Single Cell Sanctuary	4.55	20%	0.10	65%
1 ¼" Single Cell Splendor	4.35	17%	0.12	58%
1 ¼" Single Cell Valletta LF	4.35	17%	0.14	52%

Double Pane Clear Window and Window Covering					
		R Value	% Reduction of heat transfer	SHGC	% Reduction of heat transfer
¾" Single Cell	Sanctuary	2.78	23.64%	0.21	69%
½" Double Cell	Splendor	2.86	25.48%	0.24	65%
¾" Single Cell	Splendor	2.78	23.36%	0.29	57%
½" Double Cell	Sanctuary	2.86	25.87%	0.2	70%

NFRC 102 2010 performed by Architectural Testing Inc.

### R-Value

R-Value indicates the effectiveness of the window covering at preventing energy from flowing to the outside. The higher the R-Value, the greater the insulating effectiveness.

### Solar Heat Gain Coefficient (SHGC)

SHGC measures how well window covering blocks heat from the sun from flowing to the interior. SHGC is expressed as a number between 0 and 1. The lower the SHGC, the better a product is at blocking unwanted heat gain.

# General Information

## Stack Height Chart

Total Thickness				
Height of Shade (inches)	1¼" Single Cell Sanctuary, Valletta BO  ¾" Single Cell Sanctuary, Scroll FR, Simply Sheer (inches)	1¼" Single Cell Splendor, Valletta LF  ¾" Single Cell Enchantment LF & BO, Endeavor, Infuse BO, Kinsley BO, Montage LF, Montage BO, Prestige BO, Valletta BO  ⅝" Single Cell Endeavor (inches)	1¼" Single Cell Champagne Toast  ½" Double Cell Splendor  ¾" Single Cell Champagne Toast, Couture LF & BO, Discovery, Infuse LF, Kinsley LF, Prestige LF, Splendor, Valletta LF  ⅝" Single Cell Discovery (inches)	½" Double Cell Sanctuary (inches)
18	3¼	3⅝	3⅝	3¾
30	3⅝	3½	4	4¼
42	3½	3¾	4¼	4⅝
54	3⅝	3⅞	4⅝	5⅞
66	3¾	4⅞	5	5½
78	3⅞	4¼	5¼	5⅞
90	4⅞	4½	5⅝	6⅞
96	4⅞	4⅞	5¾	6⅞
108	4¼	4¾	6⅞	7
120	4⅞	5	6½	7⅞
132	4⅞	5⅞	6¾	7⅞
144	4¾	5⅞	7⅞	8¼

**NOTE:** Stack height includes headrail and bottomrail.  
 Sizes are approximate.

**⅝" Single Cell, ½" Double Cell, and ¾" Single Cell**

For bottom up/top down with cordless lift control, add ¾".

For sun up/sun down with cordless lift control, add the two fabric stacks together.

**1¼" Single Cell**

For bottom up/top down with cordless lift control add ⅝".

## General Information

### Stack Height Chart: Perfect-Vue™

All Pleated Fabrics Plus Cellular Fabrics Below				
Height of Shade (inches)	¼" Single Cell Sanctuary, Scroll FR, Simply Sheer (inches)	¾" Single Cell Enchantment LF & BO, Endeavor, Infuse BO, Kinsley BO, Montage LF & BO, Prestige BO, Valletta BO ⅝" Single Cell Endeavor (inches)	½" Double Cell Splendor ¾" Single Cell Champagne Toast, Couture LF & BO, Discovery, Infuse LF, Kinsley LF, Prestige LF, Splendor LF, Valletta LF ⅝" Single Cell Discovery (inches)	½" Double Cell Sanctuary (inches)
18	3⅝	3½	3½	3¾
30	3⅝	4	4	4¼
42	4	4½	4⅝	4¾
54	4⅝	4⅞	5⅝	5⅝
66	4¾	5⅝	5⅝	5⅞
78	5⅝	5⅞	6⅝	6⅞
90	5½	6¼	6⅝	7
96	5⅝	6½	6⅞	7¼

**NOTE:** Sizes are approximate.

Stack height includes all rails and both pleated and cellular fabrics together, but is based on the cellular fabric chosen.

Sheer pleated fabric was used for calculation.

## General Information

### Stack Width Chart Slide-View™

Height of shade is indicated across the top and width of shade is indicated on the left side of chart.

Shade Stack Width Includes Side Rails									
Width of Shade (inches)	1¼" Single Cell Champagne Toast, Sanctuary, Splendor, Valletta LF & BO		¾" Single Cell Champagne Toast, Couture LF & BO, Discovery, Enchantment LF& BO, Infuse LF & BO, Kinsley BO, Montage LF & BO, Prestige LF & BO, Scroll FR, Splendor, Valletta LF & BO (inches)		½" Double Cell Splendor (inches)		½" Double Cell Sanctuary (inches)		
Height of Shade → (inches)	< 72	120*	< 72	120*	< 72	120*	< 72	120	
Width of Shade (inches)	72	9⅝	13	9⅝	13	9%	13	9%	13
	84	9⅝	13	9⅝	13	9%	13	9%	13
	96	9⅝	13	9⅝	13	9%	13	9%	13
	108	9⅝	13	9⅝	13	9%	13	9%	13
	120	9⅝	13	9⅝	13	9%	13	9%	13
	132	9⅝	13	9⅝	13	9%	13	10⅝	13
	144	9⅝	13	9⅝	13	9%	13	10¾	13
	156	9⅝	13	9⅝	13	9¼	13	11⅝	13
	168	9⅝	13	9½	13	10%	13	12	13¼
	180	9½	13	9⅝	13	10¼	13	12%	14⅝
192	9⅝	13	10¼	13	11%	13¾	13%	15	

**NOTE:** For a clear opening on either side of the window, stack width must be doubled.  
Shades less than 72" use a short side rail bracket which may change the stack width.

### Standard Handle Location for Slide-View

#### Standard Handle Location

- Up to 98" finished shade height the handle is centered on side rails
- 98⅙" to 120" finished shade height: the handle will be 48" from the bottom of the side rails

#### Special Handle Height Location

- For specifications see chart

Slide-View Shade Special Handle Location Chart		
Shade Height Less Than or Equal to (inches)	Minimum Handle Distance from Bottom of Shade (inches)	Maximum Handle Distance from Bottom of Shade (inches)
24 to 36	11	16
36⅙ to 46	11	28
46⅙ to 62	13	29
62⅙ to 74	15	30
74⅙ to 86	15	36
86⅙ to 98	15	42
98⅙ to 108	34	49
108⅙ to 120	46	50

**NOTE:** Handle height is to center of handle.

## General Information

### Cellular Shade Color Coordination Chart

Color Name	Default Rail Color Coordination	Color Number	Default Slide-Vue™ and Side Channel Color Name	Color Number
<b>Splendor</b>				
Arctic Lichen	Faded Sea Foam	198	White Satin	205
Arctic White	Cream	715	Cream	715
Blanched Coral	Quietude	188	Creamy Pearl	356
Bourgogne	Fog	574	White Satin	205
Cabernet	Clover	049	White Satin	205
Champagne	Vanilla	100	Cream	715
Coastal Nuance	Vanilla	100	Cream	715
Cocoa Nib	Lamplight	904	Cream	715
Cornerstone	Twine	439	Creamy Pearl	356
Ebb & Flow	Ice	778	White Satin	205
Eggnog	Creamy Pearl	356	Creamy Pearl	356
Elusive Gray	White Satin	205	White Satin	205
Endless Summer	Open Seas	186	White Satin	205
Etched Stone	Etched Stone	195	White Satin	205
Freshwater Pearl	White Satin	205	White Satin	205
Gentle Tan	Revere Pewter	190	Revere Pewter	190
Glacier Bay	White Satin	205	White Satin	205
Golden Wheat	Camel	086	Cream	715
Gray Dusk	Arctic Seal	183	White Satin	205
Gray Fedora	Black Satin	233	White Satin	205
Gray Moss	Gray Moss	199	White Satin	205
Harvested Wheat	Lamplight	904	Cream	715
Heather Mist	Etched Stone	195	White Satin	205
Hushed Gray	Canyon Gray	053	Canyon Gray	053
Irish Coffee	Sable	565	Sable	565
Liquid Silver	Smokey Gray	026	Smokey Gray	026
Matte Plum	Fog	574	White Satin	205
Monsoon	Plebian Blue	221	White Satin	205
Mulberry Grape	Bordeaux	359	White Satin	205
Natural Beige	Lamplight	904	Cream	715
Navy Charm	Navy	369	White Satin	205
Nicoise	Iron Gate	185	White Satin	205
Nostalgic Beige	Lamplight	904	Creamy Pearl	356
Penguin	Revere Pewter	190	Revere Pewter	190
Pink Limestone	White Satin	205	White Satin	205
Plebian Blue	Plebian Blue	221	White Satin	205
Powder Gray	White Satin	205	White Satin	205
River Stone	Canyon Gray	053	Canyon Gray	053
Rose Colored Glass	Watermelon Punch	196	White Satin	205
Sandpiper	Creamy Pearl	356	Creamy Pearl	356
Shadow Frost	Ice	778	White Satin	205
Shell White	Cream	715	Cream	715
Stallion	Iron Gate	185	Canyon Gray	053
Sweetwater Sage	Acacia Haze	182	Smokey Gray	026
Thunder Dusk	Navy	369	White Satin	205
Thyme	Acacia Haze	182	Smokey Gray	026
Timberwolf Gray	Smokey Gray	026	Smokey Gray	026
Toasted Pecan	Praline	108	Sable	565
Tonal Taupe	Twine	439	Sable	565
Tuscan Red	Sangria	059	White Satin	205
Watermelon Punch	Watermelon Punch	196	White Satin	205
Whisper White	White Satin	205	White Satin	205

## General Information

### Cellular Shade Color Coordination Chart (continued)

Color Name	Default Rail Color Coordination	Color Number	Default Slide-Vue™ and Side Channel Color Name	Color Number
<b>Sanctuary</b>				
Arctic Lichen	Faded Sea Foam	198	White Satin	205
Arctic White	Cream	715	Cream	715
Blanched Coral	Quietude	188	Creamy Pearl	356
Bourgogne	Fog	574	White Satin	205
Cabernet	Clover	049	White Satin	205
Champagne	Vanilla	100	Cream	715
Coastal Nuance	Vanilla	100	Cream	715
Cocoa Nib	Lamplight	904	Cream	715
Cornerstone	Twine	439	Creamy Pearl	356
Ebb & Flow	Ice	778	White Satin	205
Eggnog	Creamy Pearl	356	Creamy Pearl	356
Elusive Gray	White Satin	205	White Satin	205
Endless Summer	Open Seas	186	White Satin	205
Etched Stone	Etched Stone	195	White Satin	205
Freshwater Pearl	White Satin	205	White Satin	205
Gentle Tan	Revere Pewter	190	Revere Pewter	190
Glacier Bay	White Satin	205	White Satin	205
Golden Wheat	Camel	086	Cream	715
Gray Dusk	Arctic Seal	183	White Satin	205
Gray Fedora	Black Satin	233	White Satin	205
Gray Moss	Gray Moss	199	White Satin	205
Harvested Wheat	Lamplight	904	Cream	715
Heather Mist	Etched Stone	195	White Satin	205
Hushed Gray	Canyon Gray	053	Canyon Gray	053
Irish Coffee	Sable	565	Sable	565
Liquid Silver	Smokey Gray	026	Smokey Gray	026
Matte Plum	Fog	574	White Satin	205
Monsoon	Plebian Blue	221	White Satin	205
Mulberry Grape	Bordeaux	359	White Satin	205
Natural Beige	Lamplight	904	Cream	715
Navy Charm	Navy	369	White Satin	205
Nicoise	Iron Gate	185	White Satin	205
Nostalgic Beige	Lamplight	904	Creamy Pearl	356
Penguin	Revere Pewter	190	Revere Pewter	190
Pink Limestone	White Satin	205	White Satin	205
Plebian Blue	Plebian Blue	221	White Satin	205
Powder Gray	White Satin	205	White Satin	205
River Stone	Canyon Gray	053	Canyon Gray	053
Rose Colored Glass	Watermelon Punch	196	White Satin	205
Sandpiper	Creamy Pearl	356	Creamy Pearl	356
Shadow Frost	Ice	778	White Satin	205
Shell White	Cream	715	Cream	715
Stallion	Iron Gate	185	Canyon Gray	053
Sweetwater Sage	Acacia Haze	182	Smokey Gray	26
Thunder Dusk	Navy	369	White Satin	205
Thyme	Acacia Haze	182	Smokey Gray	026
Timberwolf Gray	Smokey Gray	026	Smokey Gray	026
Toasted Pecan	Praline	108	Sable	565
Tonal Taupe	Twine	439	Sable	565
Watermelon Punch	Watermelon Punch	196	White Satin	205
Whisper White	White Satin	205	White Satin	205



## General Information

### Cellular Shade Color Coordination Chart (continued)

Color Name	Default Rail Color Coordination	Color Number	Default Slide-Vue™ and Side Channel Color Name	Color Number
<b>Endeavor</b>				
Elegant Dove	Smokey Gray	026	Smokey Gray	026
Llama	Cream	715	Cream	715
Pier	Lamplight	904	Cream	715
Thickened Cream	Vanilla	100	Cream	715
White Radish	White Satin	205	White Satin	205
<b>Discovery</b>				
Elegant Dove	Smokey Gray	026	Smokey Gray	026
Llama	Cream	715	Cream	715
Pier	Lamplight	904	Cream	715
Thickened Cream	Vanilla	100	Cream	715
White Radish	White Satin	205	White Satin	205
<b>Couture Light Filtering/Couture Blackout</b>				
Feather White	White Satin	205	White Satin	205
Heron Plume	Twine	439	Creamy Pearl	356
Jute	Iron Gate	185	Canyon Gray	053
Noble Pewter	Smokey Gray	026	Smokey Gray	026
Peaceful Gray	Canyon Gray	053	Canyon Gray	053
<b>Valletta Light Filtering/Valletta Blackout</b>				
Coconut Cream	Cream	715	Cream	715
Crisp Carbon	Arctic Seal	183	White Satin	205
Gourmet Chocolate	Sable	565	Sable	565
Gray Moss	Gray Moss	199	White Satin	205
Indigo Intrigue	Navy	369	White Satin	205
Manila	Creamy Pearl	356	Creamy Pearl	356
Plebian Blue	Plebian Blue	221	White Satin	205
Simply White	White Satin	205	White Satin	205
Stallion	Iron Gate	185	Canyon Gray	053
Trevi	Canyon Gray	053	Canyon Gray	053
<b>Prestige Light Filtering/Prestige Blackout</b>				
Beige Influence	Canyon Gray	053	Canyon Gray	053
Gray Juniper	Smokey Gray	026	Smokey Gray	026
Pale Pebble	White Satin	205	White Satin	205
Refined Flax	Revere Pewter	190	Revere Pewter	190
Sophisticated Stone	Online	187	Smokey Gray	026
<b>Montage Light Filtering/Montage Blackout</b>				
Chroma Gray	Etched Stone	195	White Satin	205
Cultivated Khaki	Revere Pewter	190	Revere Pewter	190
Gray Granite	White Satin	205	White Satin	205
Gray Hues	Online	187	Smokey Gray	026
Gray Moon	Canyon Gray	053	Canyon Gray	053
<b>Enchantment Light Filtering/Enchantment Blackout</b>				
Genteel Beige	Cream	715	Cream	715
Glacial Gray	Online	187	White Satin	205
Regal Gray	Revere Pewter	190	Revere Pewter	190
Ridged Sand	Revere Pewter	190	Revere Pewter	190
Silver Shadow	White Satin	205	White Satin	205
<b>Infuse Light Filtering/Infuse Blackout</b>				
Aspen	White Satin	205	White Satin	205
Autumn Gold	Camel	086	Creamy Pearl	356
Balanced Beige	Revere Pewter	190	Revere Pewter	190
Ecrú	Creamy Pearl	356	Creamy Pearl	356
Indigo Intrigue	Navy	369	White Satin	205
Rivermist	Online	187	Smokey Gray	026
Savvy Slate	Arctic Seal	183	White Satin	205
Subtle Sage	Acacia Haze	182	Smokey Gray	026
Taupe Perfection	Tender Taupe	103	Sable	565
Vanilla Cream	Cream	715	Cream	715

## General Information

### Cellular Shade Color Coordination Chart (continued)

Color Name	Default Rail Color Coordination	Color Number	Default Slide-Vue™ and Side Channel Color Name	Color Number
<b>Kinsley Light Filtering/Kinsley Blackout</b>				
Aspen	White Satin	205	White Satin	205
Autumn Gold	Camel	086	Creamy Pearl	356
Balanced Beige	Revere Pewter	190	Revere Pewter	190
Ecu	Creamy Pearl	356	Creamy Pearl	356
Indigo Intrigue	Navy	369	White Satin	205
Rivermist	Online	187	Smokey Gray	026
Savvy Slate	Arctic Seal	183	White Satin	205
Subtle Sage	Acacia Haze	182	Smokey Gray	026
Taupe Perfection	Tender Taupe	103	Sable	565
Vanilla Cream	Cream	715	Cream	715
<b>Scroll FR</b>				
Adirondack	Tender Taupe	103	Sable	565
Manila	Creamy Pearl	356	Creamy Pearl	356
Simply White	White Satin	205	White Satin	205
Spring Fawn	Twine	439	Creamy Pearl	356
Trevi	Canyon Gray	053	Canyon Gray	053
<b>Simply Sheer</b>				
Almond	Creamy Pearl	356	Creamy Pearl	356
Steel Harbor	Online	187	Smokey Gray	026
Whisper	White Satin	205	White Satin	205
<b>Champagne Toast</b>				
Baroque	Gray Moss	199	White Satin	205
Elfin Woodland	Online	187	Smokey Gray	026
Jet Black	Arctic Seal	183	White Satin	205
Metallic Mauve	Canyon Gray	053	Canyon Gray	053
Nutmeg Gleam	Revere Pewter	190	Revere Pewter	190
Piquant	Tender Taupe	103	Sable	565
Pristine	Canyon Gray	053	Canyon Gray	053
Stonemired	Creamy Pearl	356	Creamy Pearl	356
Thicket Gloss	Plebian Blue	221	White Satin	205
Wild Mink Shimmer	White Satin	205	White Satin	205

# General Information

## Cordless Lift Product Detail

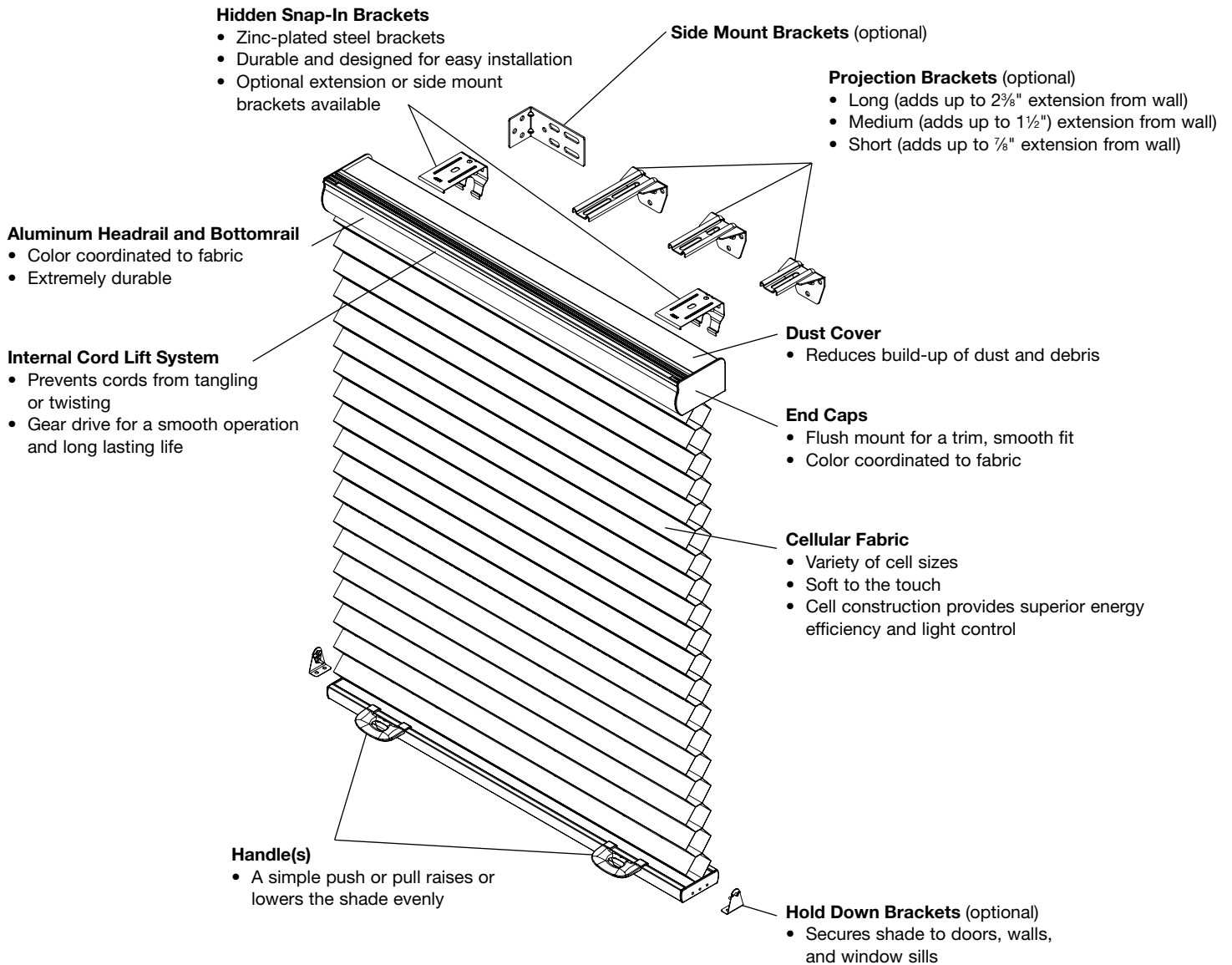

**NOTE:** Cordless lift shades should only be used on windows where consumers can comfortably raise and lower the shade with their hands and have easy access. Adding a sky pole is suggested for hard-to-reach applications, up to 24" wide. Two sky poles are recommended to ensure even operation for shades over 24" wide.

# General Information

## Continuous-Loop Lift Product Detail

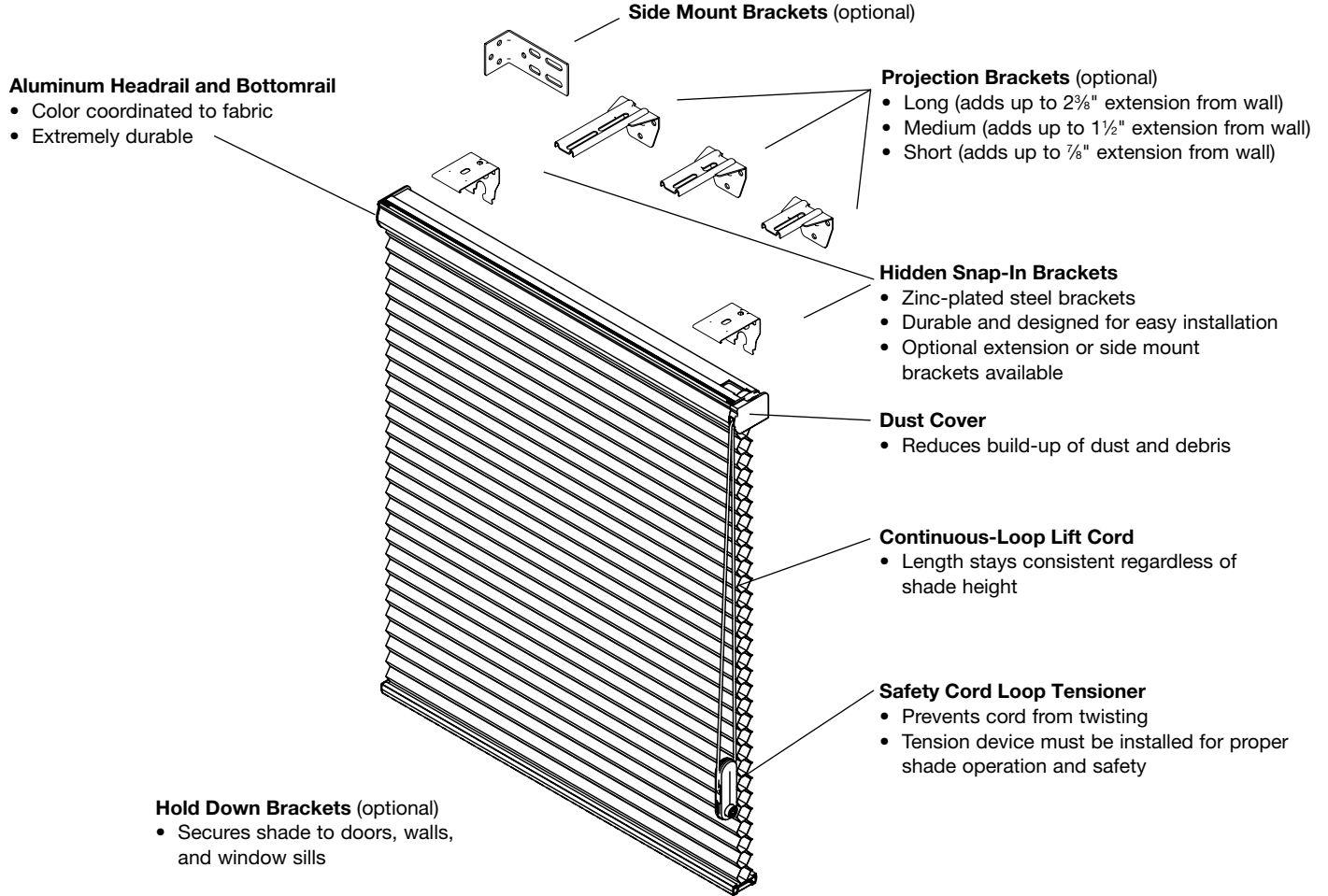

# General Information

## Bottom Up/Top Down Cordless Lift Product Detail

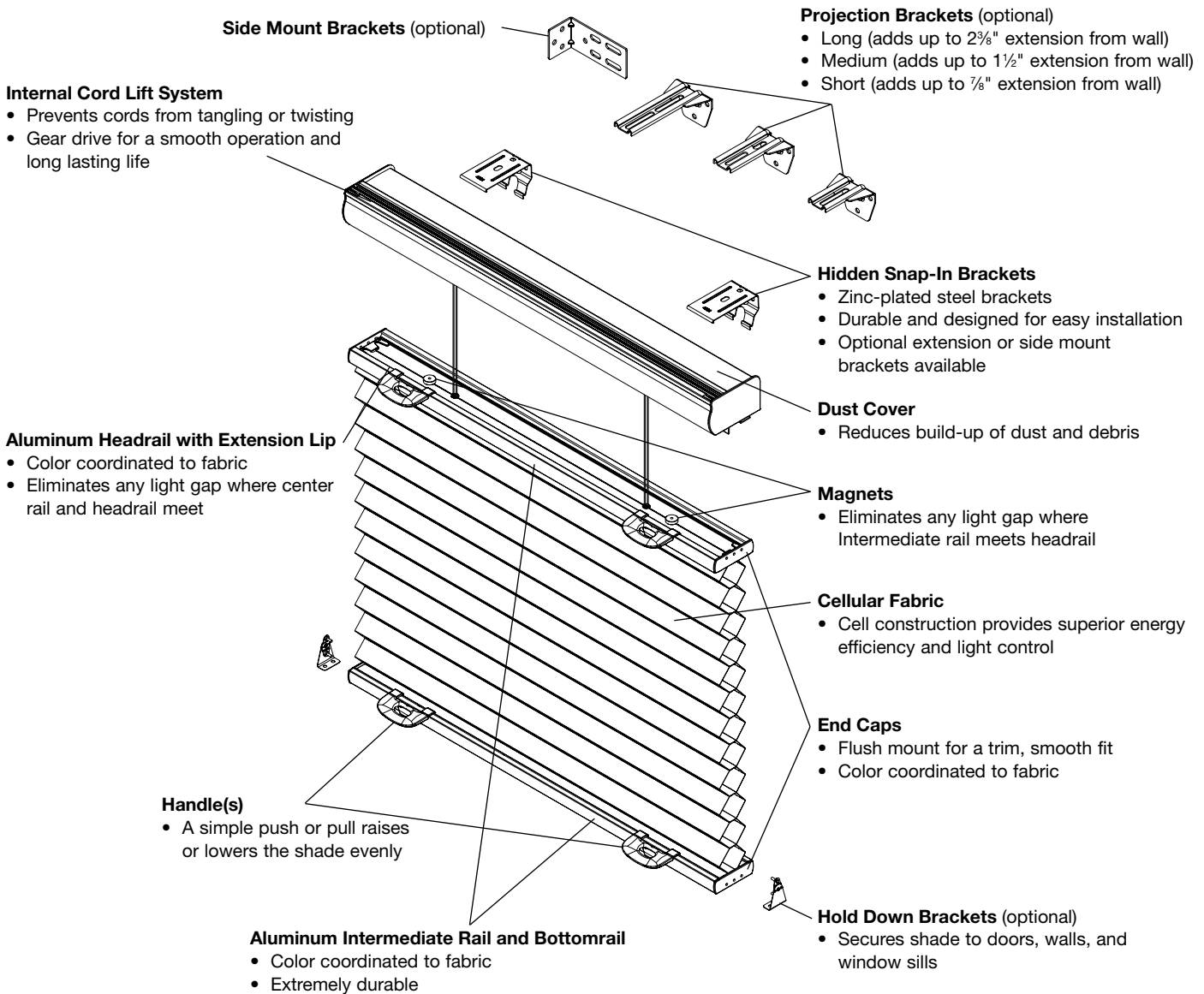

**NOTE:** Cordless lift shades should only be used on windows where consumers can comfortably raise and lower the shade with their hands and have easy access.

# General Information

## Cordless Lift Product Detail Perfect-Vue™

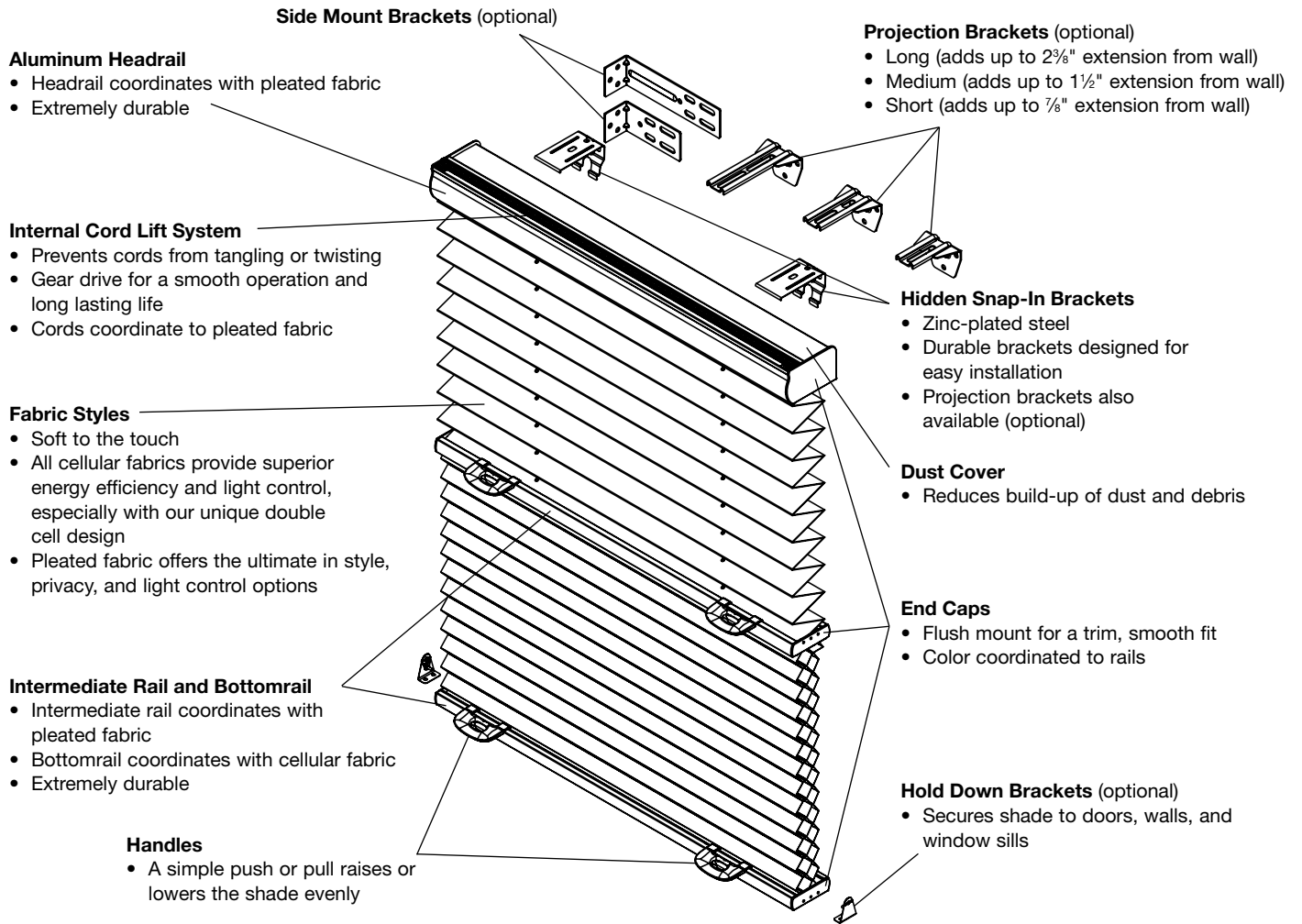

View from Back of Shade

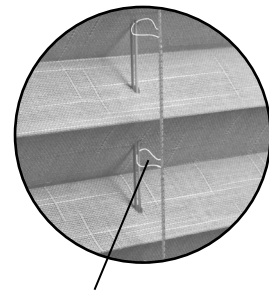

**EvenPleat® (optional)**  
EvenPleat offers a unique ladder system to guarantee pleats will not flatten.

**NOTE:** Cordless lift shades should only be used on windows where consumers can comfortably raise and lower the shade with their hands and have easy access.

# General Information

## Slide-Vue™ Product Detail

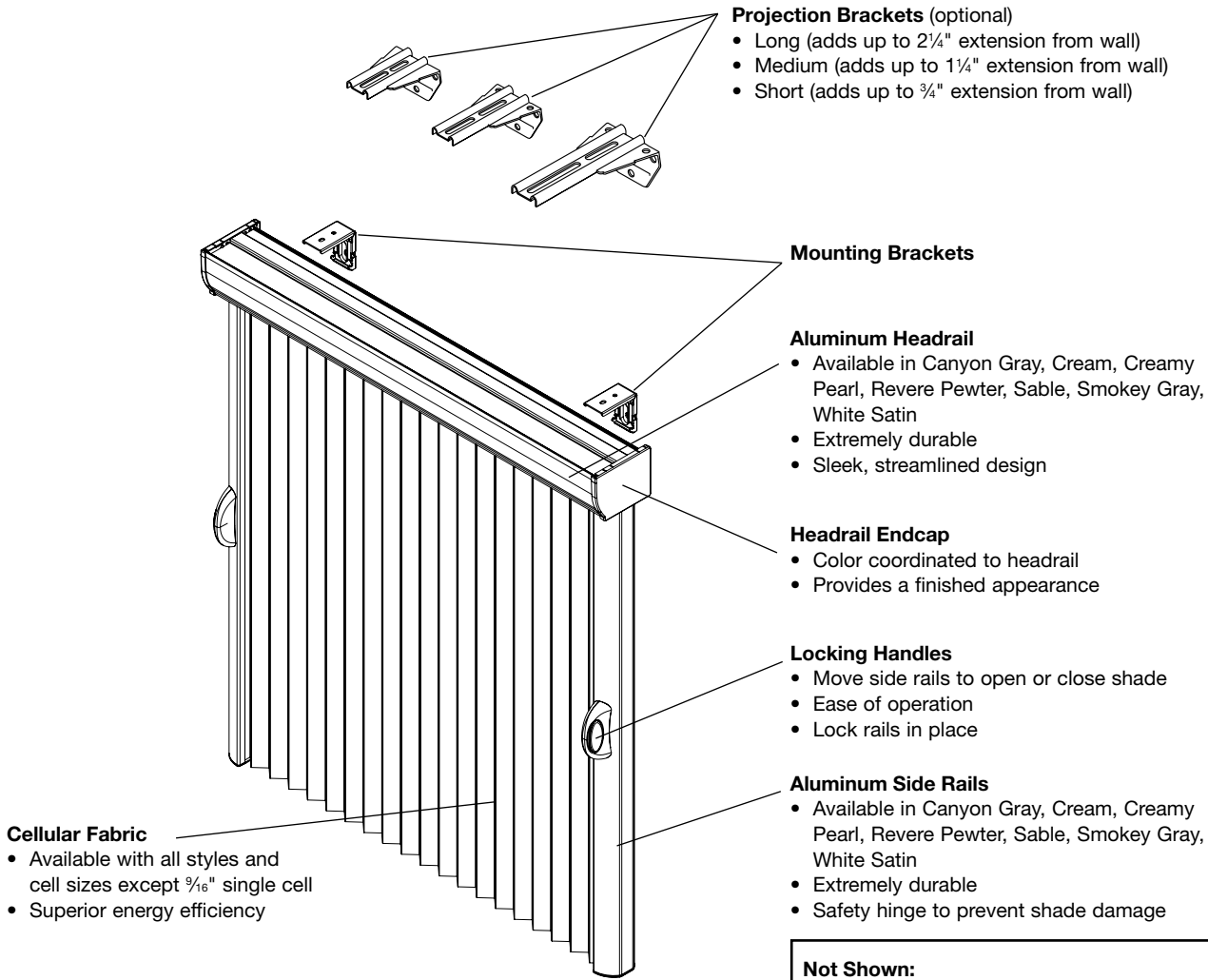

### Application:

- Ideal for patio doors, wide windows, and room dividers
- Movable side rails with locking handles for ease of operation
- Allows stack of material to be positioned on the right, center, or left
- Easy to install
- Slim, compact stack

### Not Shown:

- Safety release fabric stem  
Releases from carriage to prevent fabric from tearing
- Cornices or valances (optional)  
Refer to the cornices and valances product information guide for product specifications

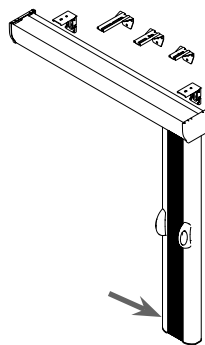

Stack Right

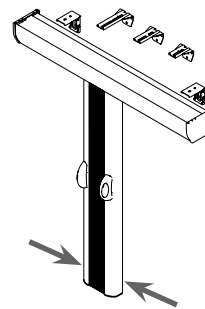

Stack Center

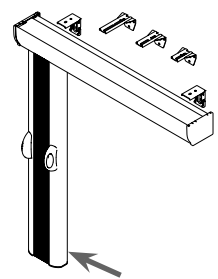

Stack Left

# GRABER®

Grabber is a brand of Springs Window Fashions, the Best Experience Company

Grabber and the Grabber logo are registered trademarks of Springs Window Fashions, LLC.

(5/24) 23-513400

# GRABER.

## Grabber CrystalPleat® Cellular Shades

Designer US Price List — Effective February 2025

### Price Group A: Endeavor 9/16" (1.0 cm) Single Cell

Height up to inches (cm) ↓	Width up to inches (cm) →																
	24 (61)	30 (76.2)	36 (91.5)	42 (106.7)	48 (122)	54 (137.2)	60 (152.4)	66 (167.7)	72 (182.9)	84 (213.4)	96 (243.9)	108 (274.4)	120 (304.8)	132 (335.3)	144 (365.8)	174 (442)	192 (487.7)
36 (91.5)	209	226	260	288	326	351	375	408	435	503	567	700	758	821	876	1000	1128
42 (106.7)	220	252	281	320	351	381	421	452	486	547	608	770	837	907	969	1104	1218
48 (122)	235	266	308	345	375	421	453	493	529	604	680	833	907	983	1059	1211	1371
54 (137.2)	253	282	329	367	408	452	491	533	571	654	743	900	980	1060	1143	1308	1492
60 (152.4)	263	308	351	393	435	483	529	571	614	711	802	965	1056	1143	1236	1417	1617
66 (167.7)	280	326	370	421	471	514	567	613	667	763	868	1036	1129	1223	1322	1521	1731
72 (182.9)	288	342	393	443	503	547	603	654	708	816	929	1104	1203	1304	1414	1626	1850
78 (198.2)	308	359	416	472	529	588	645	699	750	865	989	1172	1280	1388	1512	1726	1969
84 (213.4)	320	370	434	493	563	618	676	740	798	915	1047	1243	1359	1476	1593	1822	2097
90 (228.6)	331	393	455	514	593	654	717	779	842	965	1109	1304	1435	1554	1684	1928	2217
96 (243.9)	347	416	478	542	618	684	754	821	889	1021	1169	1381	1513	1643	1772	2035	2334
108 (274.4)	374	453	527	602	677	758	830	907	983	1128	1295	1520	1666	1814	1960	2249	2589
120 (304.8)	408	491	571	654	743	827	907	989	1074	1238	1417	1648	1816	1972	2141	2472	2832
132 (335.3)	435	529	614	708	799	898	985	1075	1163	1343	1535	1791	1968	2147	2323	2684	3068
144 (365.8)	472	569	667	758	865	965	1059	1155	1254	1450	1658	1928	2119	2311	2503	2895	3318

NOTE: Cordless lift maximum height is 86" (218.5 cm). Cordless lift continuous shades available in outlined area above.

NOTE: Continuous width fabric up to 144" (365.8 cm).

Endeavor 9/16" Single Cell*					
Elegant Dove	5816	Pier	5805	White Radish	5800
Llama	5801	Thickened Cream	5802		

\*Color coordinated with Discovery (blackout)



## Price Group B: Endeavor 3/4" (2.0 cm) Single Cell

Height up to inches (cm) ↓	Width up to inches (cm) →																
	24 (61)	30 (76.2)	36 (91.5)	42 (106.7)	48 (122)	54 (137.2)	60 (152.4)	66 (167.7)	72 (182.9)	84 (213.4)	96 (243.9)	108 (274.4)	120 (304.8)	132 (335.3)	144 (365.8)	174 (442)	192 (487.7)
36 (91.5)	222	247	277	309	343	369	404	433	463	530	600	739	801	869	926	1059	1192
42 (106.7)	234	263	303	334	369	408	440	478	515	582	646	806	886	954	1022	1165	1294
48 (122)	252	282	324	365	404	440	479	519	561	640	724	883	955	1039	1120	1278	1451
54 (137.2)	264	304	347	389	433	478	518	563	605	693	788	950	1038	1123	1213	1384	1577
60 (152.4)	280	324	369	418	463	508	561	605	651	749	851	1018	1118	1213	1304	1497	1708
66 (167.7)	300	343	393	440	494	544	600	649	700	802	916	1087	1194	1298	1396	1606	1836
72 (182.9)	309	363	418	474	530	582	637	688	744	861	980	1165	1272	1381	1494	1721	1962
78 (198.2)	324	375	437	495	561	622	676	738	797	915	1047	1241	1351	1475	1595	1827	2088
84 (213.4)	334	393	460	519	594	657	718	783	846	970	1109	1317	1435	1563	1681	1926	2215
90 (228.6)	351	418	482	544	624	688	759	822	888	1018	1172	1381	1516	1646	1778	2038	2346
96 (243.9)	368	437	504	577	657	727	799	869	941	1080	1238	1455	1596	1734	1872	2150	2468
108 (274.4)	398	479	556	636	719	801	879	955	1039	1192	1370	1603	1761	1913	2079	2383	2738
120 (304.8)	433	518	605	688	788	873	955	1047	1135	1308	1497	1743	1920	2091	2265	2612	2995
132 (335.3)	463	561	651	744	849	948	1042	1136	1227	1417	1624	1897	2087	2270	2460	2830	3250
144 (365.8)	495	601	700	801	915	1018	1120	1219	1325	1534	1754	2038	2239	2447	2647	3061	3508

**NOTE:** Cordless lift maximum height is 86" (218.5 cm). Cordless lift continuous shades available in outlined area above.

**NOTE:** Continuous width fabric up to 144" (365.8 cm).

Endeavor 3/4" Single Cell*					
Elegant Dove	0374	Pier	0378	White Radish	0381
Llama	0377	Thickened Cream	0380		

\*Color coordinated with Discovery (blackout)

## Price Group C: Splendor 3/4" (2.0 cm) Single Cell

Height up to inches (cm) ↓	Width up to inches (cm) →																
	24 (61)	30 (76.2)	36 (91.5)	42 (106.7)	48 (122)	54 (137.2)	60 (152.4)	66 (167.7)	72 (182.9)	84 (213.4)	96 (243.9)	108 (274.4)	120 (304.8)	132 (335.3)	144 (365.8)	174 (442)	192 (487.7)
36 (91.5)	274	306	351	392	433	465	503	545	583	664	749	929	1009	1088	1166	1329	1504
42 (106.7)	297	333	380	422	465	511	559	596	645	735	812	1020	1110	1198	1284	1471	1621
48 (122)	309	358	404	456	503	559	600	652	702	807	914	1108	1205	1307	1406	1605	1822
54 (137.2)	334	382	437	492	545	596	651	709	759	873	989	1197	1306	1418	1523	1741	1980
60 (152.4)	354	402	465	525	583	645	702	759	822	944	1074	1283	1403	1523	1638	1888	2143
66 (167.7)	366	433	495	559	626	688	750	814	880	1011	1152	1372	1506	1630	1762	2021	2303
72 (182.9)	392	455	525	590	664	734	798	872	943	1083	1232	1468	1599	1738	1878	2160	2464
78 (198.2)	406	477	551	628	707	780	851	926	1001	1152	1317	1566	1698	1848	1998	2302	2625
84 (213.4)	422	498	578	652	743	826	907	982	1056	1214	1392	1650	1804	1968	2118	2427	2785
90 (228.6)	443	525	602	689	788	872	951	1036	1119	1283	1476	1738	1904	2071	2237	2562	2946
96 (243.9)	462	548	634	727	823	916	1003	1089	1181	1354	1560	1834	2001	2179	2355	2709	3109
108 (274.4)	482	578	675	764	873	971	1066	1158	1254	1440	1660	1938	2135	2319	2510	2881	3310
120 (304.8)	525	628	734	837	949	1055	1158	1264	1370	1579	1809	2114	2322	2529	2738	3158	3621
132 (335.3)	561	676	791	904	1026	1148	1258	1371	1487	1707	1968	2288	2518	2740	2971	3423	3928
144 (365.8)	600	732	850	971	1106	1232	1354	1478	1602	1848	2123	2464	2715	2951	3206	3700	4242

**NOTE:** Cordless lift maximum height is 86" (218.5 cm). Cordless lift continuous shades available in outlined area above.

**NOTE:** Continuous width fabric up to 144" (365.8 cm).

**NOTE:** Fabric Wrapped Rails are available with the Splendor collection in cordless, continuous cord loop and motorized lift. See options pricing for surcharge.

Splendor 3/4" Single Cell*					
Arctic Lichen	1381	Gray Fedora	1338	Rose Colored Glass	1395
Arctic White	1333	Gray Moss	1382	Sandpiper	1371
Blanched Coral	1374	Harvested Wheat	1331	Shadow Frost	1386
Bourgogne	1397	Heather Mist	1394	Shell White	1345
Cabernet	1399	Hushed Gray	1373	Stallion	1375
Champagne	1336	Irish Coffee	1324	Sweetwater Sage	1344
Coastal Nuance	1357	Liquid Silver	1320	Thunder Dusk	1389
Cocoa Nib	1378	Matte Plum	1396	Thyme	1383
Cornerstone	1372	Monsoon	1390	Timberwolf Gray	1325
Ebb & Flow	1385	Mulberry Grape	1398	Toasted Pecan	1379
Eggnog	1328	Natural Beige	1326	Tonal Taupe	1363
Elusive Gray	1367	Navy Charm	1351	Tuscan Red	1342
Endless Summer	1356	Nicoise	1384	Watermelon Punch	1392
Etched Stone	1393	Nostalgic Beige	1343	Whisper White	1321
Freshwater Pearl	1322	Penguin	1376		
Gentle Tan	1329	Pink Limestone	1391		
Glacier Bay	1387	Plebian Blue	1388		
Golden Wheat	1355	Powder Gray	1334		
Gray Dusk	1335	River Stone	1368		

\*Color coordinated with Sanctuary (blackout)

**Price Group D: Discovery 9/16" (1.0 cm) Single Cell, Splendor 1/2" (1.3 cm) Double Cell, Enchantment Light Filtering 3/4" (2.0 cm) Single Cell, Montage Light Filtering 3/4" (2.0 cm) Single Cell, Prestige Light Filtering 3/4" (2.0 cm) Single Cell**

Height up to inches (cm) ↓	Width up to inches (cm) →																
	24 (61)	30 (76.2)	36 (91.5)	42 (106.7)	48 (122)	54 (137.2)	60 (152.4)	66 (167.7)	72 (182.9)	84 (213.4)	96 (243.9)	108 (274.4)	120 (304.8)	132 (335.3)	144 (365.8)	174 (442)	192 (487.7)
36 (91.5)	301	337	382	426	472	511	555	598	639	728	824	1024	1114	1193	1284	1461	1646
42 (106.7)	325	363	419	466	511	561	614	660	707	806	886	1119	1221	1317	1418	1617	1782
48 (122)	343	393	448	499	555	612	664	721	771	881	1000	1220	1322	1436	1545	1767	2002
54 (137.2)	363	421	477	539	598	660	715	783	831	958	1089	1315	1432	1557	1672	1918	2175
60 (152.4)	384	443	511	576	639	706	771	831	902	1037	1182	1416	1540	1673	1804	2075	2355
66 (167.7)	406	472	541	614	686	757	827	899	972	1114	1263	1508	1655	1790	1934	2219	2531
72 (182.9)	426	498	576	657	728	806	878	954	1030	1188	1357	1615	1755	1913	2066	2376	2709
78 (198.2)	451	524	607	686	782	856	932	1018	1101	1263	1442	1720	1869	2032	2195	2530	2890
84 (213.4)	466	547	633	721	815	907	993	1081	1164	1335	1530	1814	1985	2161	2333	2667	3062
90 (228.6)	485	576	665	758	865	954	1052	1136	1234	1413	1621	1913	2098	2275	2457	2818	3241
96 (243.9)	505	607	696	801	903	1004	1104	1195	1294	1492	1718	2011	2203	2396	2591	2978	3418
108 (274.4)	530	633	737	844	958	1066	1172	1278	1379	1587	1818	2130	2342	2548	2757	3165	3642
120 (304.8)	576	691	804	917	1042	1163	1278	1386	1502	1735	1991	2317	2549	2784	3008	3471	3978
132 (335.3)	621	740	868	993	1125	1258	1385	1508	1636	1884	2160	2517	2767	3014	3267	3761	4315
144 (365.8)	663	801	931	1066	1217	1357	1492	1624	1763	2032	2334	2711	2980	3249	3523	4068	4657

NOTE: Cordless lift maximum height is 86" (218.5 cm). Cordless lift continuous shades available in outlined area above.

NOTE: Continuous width fabric up to 144" (365.8 cm).

NOTE: Fabric Wrapped Rails are available with the Splendor collection in cordless, continuous cord loop and motorized lift.

See options pricing for surcharge.

Discovery 9/16" Single Cell*					
Elegant Dove	5216	Pier	5205	White Radish	5200
Llama	5201	Thickened Cream	5224		

\*Color coordinated with Endeavor (light filtering)

Splendor 1/2" Double Cell**					
Arctic Lichen	1517	Gray Fedora	1538	Rose Colored Glass	1585
Arctic White	1533	Gray Moss	1518	Sandpiper	1571
Blanched Coral	1590	Harvested Wheat	1531	Shadow Frost	1576
Bourgogne	1587	Heather Mist	1584	Shell White	1545
Cabernet	1589	Hushed Gray	1573	Stallion	1591
Champagne	1536	Irish Coffee	1524	Sweetwater Sage	1544
Coastal Nuance	1557	Liquid Silver	1520	Thunder Dusk	1579
Cocoa Nib	1514	Matte Plum	1586	Thyme	1519
Cornerstone	1572	Monsoon	1580	Timberwolf Gray	1525
Ebb & Flow	1575	Mulberry Grape	1588	Toasted Pecan	1515
Eggnog	1528	Natural Beige	1526	Tonal Taupe	1563
Elusive Gray	1567	Navy Charm	1551	Tuscan Red	1542
Endless Summer	1556	Nicoise	1574	Watermelon Punch	1582
Etched Stone	1583	Nostalgic Beige	1543	Whisper White	1521
Freshwater Pearl	1522	Penguin	1512		
Gentle Tan	1529	Pink Limestone	1581		
Glacier Bay	1577	Plebian Blue	1578		
Golden Wheat	1555	Powder Gray	1534		
Gray Dusk	1535	River Stone	1568		

\*\*Color coordinated with Sanctuary (blackout)

Enchantment Light Filtering 3/4" Single Cell					
Gentle Beige	0620	Regal Gray	0621	Silver Shadow	0622
Glacial Gray	0623	Ridged Sand	0624		

\*Color coordinated with Enchantment Blackout

Montage Light Filtering 3/4" Single Cell					
Chroma Gray	0613	Gray Granite	0610	Gray Moon	0612
Cultivated Khaki	0611	Gray Hues	0614		

\*Color coordinated with Montage Blackout

Prestige Light Filtering 3/4" Single Cell					
Beige Influence	0590	Refined Flax	0592	Sophisticated Stone	0591
Gray Juniper	0594	Pale Pebble	0593		

\*Color coordinated with Prestige Blackout

**Price Group E: Discovery 3/4" (2.0 cm) Single Cell, Scroll FR 3/4" (2.0 cm) Single Cell**

Height up to inches (cm) ↓	Width up to inches (cm) →																
	24 (61)	30 (76.2)	36 (91.5)	42 (106.7)	48 (122)	54 (137.2)	60 (152.4)	66 (167.7)	72 (182.9)	84 (213.4)	96 (243.9)	108 (274.4)	120 (304.8)	132 (335.3)	144 (365.8)	174 (442)	192 (487.7)
36 (91.5)	309	341	390	438	483	520	563	608	654	741	839	1040	1124	1216	1301	1485	1679
42 (106.7)	330	370	420	474	520	569	623	665	719	823	903	1138	1242	1342	1437	1639	1811
48 (122)	360	399	452	507	563	623	668	729	784	899	1020	1239	1346	1458	1568	1795	2035
54 (137.2)	371	425	488	546	608	665	727	792	845	974	1107	1335	1456	1584	1699	1948	2211
60 (152.4)	395	450	520	590	654	719	784	845	920	1055	1197	1436	1566	1699	1830	2104	2395
66 (167.7)	411	483	551	623	699	770	840	908	985	1125	1286	1534	1682	1819	1966	2259	2571
72 (182.9)	438	506	590	663	741	820	895	972	1054	1210	1376	1637	1784	1942	2100	2411	2751
78 (198.2)	453	533	611	700	786	870	952	1036	1117	1286	1470	1750	1894	2066	2230	2569	2935
84 (213.4)	474	556	643	729	830	924	1008	1096	1183	1356	1553	1843	2014	2196	2367	2715	3111
90 (228.6)	494	590	672	771	875	972	1062	1157	1254	1436	1650	1942	2126	2314	2498	2865	3291
96 (243.9)	518	610	707	812	921	1023	1119	1217	1319	1512	1738	2050	2234	2432	2634	3032	3473
108 (274.4)	538	643	753	854	974	1082	1187	1294	1402	1612	1852	2168	2383	2589	2802	3220	3698
120 (304.8)	590	700	820	932	1058	1182	1294	1409	1532	1764	2019	2361	2593	2825	3057	3528	4044
132 (335.3)	625	754	883	1007	1149	1282	1405	1533	1661	1907	2196	2557	2811	3059	3317	3823	4387
144 (365.8)	668	815	951	1082	1235	1376	1512	1651	1790	2066	2374	2751	3034	3298	3578	4133	4740

NOTE: Cordless lift maximum height is 86" (218.5 cm). Cordless lift continuous shades available in outlined area above.

NOTE: Continuous width fabric up to 144" (365.8 cm).

<b>Discovery 3/4" Single Cell*</b>					
Elegant Dove	0191	Pier	0194	White Radish	0195
Llama	0193	Thickened Cream	0212		

\*Color coordinated with Endeavor (light filtering)

<b>Scroll FR 3/4" Single Cell</b>					
Adirondack	2916	Simply White	2901	Trevi	2918
Manila	2914	Spring Fawn	2915		

**Price Group F: Enchantment Blackout 3/4" (2.0 cm) Single Cell, Infuse Light Filtering 3/4" (2.0 cm) Single Cell, Montage Blackout 3/4" (2.0 cm) Single Cell, Prestige Blackout 3/4" (2.0 cm) Single Cell, Sanctuary 3/4" (2.0 cm) Single Cell, Sanctuary 1/2" (1.3 cm) Double Cell, Simply Sheer 3/4" (2.0cm) Single Cell, Splendor 1 1/4" (3.2 cm) Single Cell**

Height up to inches (cm) ↓	Width up to inches (cm) →																
	24 (61)	30 (76.2)	36 (91.5)	42 (106.7)	48 (122)	54 (137.2)	60 (152.4)	66 (167.7)	72 (182.9)	84 (213.4)	96 (243.9)	108 (274.4)	120 (304.8)	132 (335.3)	144 (365.8)	174 (442)	192 (487.7)
36 (91.5)	357	400	453	505	559	607	655	708	760	862	1114	1212	1308	1413	1515	1724	2227
42 (106.7)	385	426	492	551	607	663	719	779	837	952	1212	1323	1445	1560	1673	1907	2425
48 (122)	406	462	526	594	655	719	781	853	915	1043	1308	1440	1565	1698	1824	2084	2614
54 (137.2)	435	496	566	635	708	774	848	921	988	1130	1413	1549	1687	1841	1977	2260	2830
60 (152.4)	456	524	603	679	757	833	915	988	1068	1223	1512	1670	1822	1977	2127	2451	3018
66 (167.7)	487	559	642	719	812	895	980	1056	1146	1313	1616	1780	1954	2118	2284	2620	3235
72 (182.9)	505	587	679	769	862	952	1042	1128	1220	1402	1722	1905	2078	2257	2442	2806	3443
78 (198.2)	527	615	713	812	916	1012	1105	1200	1300	1493	1825	2027	2207	2395	2598	2985	3649
84 (213.4)	551	650	750	853	961	1071	1176	1275	1376	1576	1929	2141	2345	2550	2749	3149	3856
90 (228.6)	574	679	785	897	1020	1128	1236	1346	1454	1666	2036	2257	2474	2684	2887	3333	4069
96 (243.9)	601	709	824	942	1069	1191	1300	1413	1532	1759	2137	2377	2604	2830	3062	3515	4273
108 (274.4)	610	734	854	970	1105	1224	1346	1467	1593	1827	2178	2457	2702	2936	3177	3652	4303
120 (304.8)	629	747	869	991	1128	1264	1380	1503	1628	1875	2203	2522	2762	3005	3271	3752	4412
132 (335.3)	658	791	921	1053	1198	1348	1467	1598	1731	1997	2343	2681	2936	3196	3492	3989	4686
144 (365.8)	695	834	972	1111	1267	1427	1556	1694	1833	2121	2479	2837	3111	3387	3708	4239	4961

**NOTE:** Cordless lift maximum height is 86" (218.5 cm). Cordless lift continuous shades available in outlined area above.

**NOTE:** Continuous width fabric up to 144" (365.8 cm).

**NOTE:** 1 1/4" (3.2 cm) single cell fabrics are only available in cordless lift, bottom up/top down cordless lift, and motorized lift.

**NOTE:** Fabric Wrapped Rails are available with the Splendor and Sanctuary collections in cordless, continuous cord loop and motorized lift. See options pricing for surcharge.

Enchantment Blackout 3/4" Single Cell*					
Gentee Beige	0625	Regal Gray	0627	Silver Shadow	0629
Glacial Gray	0626	Ridged Sand	0628		

\*Color coordinated with Enchantment Light Filtering

Infuse Light Filtering 3/4" Single Cell*					
Aspen	0950	Indigo Intrigue	0954	Taupe Perfection	0958
Autumn Gold	0951	Rivermist	0955	Vanilla Cream	0959
Balanced Beige	0952	Savvy Slate	0956		
Ecran	0953	Subtle Sage	0957		

\*Color coordinated with Infuse Blackout

Montage Blackout 3/4" Single Cell*					
Chroma Gray	0615	Gray Granite	0617	Gray Moon	0619
Cultivated Khaki	0616	Gray Hues	0618		

\*Color coordinated with Montage Light Filtering

Prestige Blackout 3/4" Single Cell*					
Beige Influence	0595	Pale Pebble	0597	Sophisticated Stone	0599
Gray Juniper	0596	Refined Flax	0598		

\*Color coordinated with Prestige Light Filtering

Sanctuary 1/2" Double Cell*					
Arctic Lichen	1487	Gray Fedora	1455	Rose Colored Glass	5161
Arctic White	1451	Gray Moss	1488	Sandpiper	1477
Blanched Coral	1480	Harvested Wheat	1449	Shadow Frost	1492
Bourgogne	5163	Heather Mist	5160	Shell White	1461
Cabernet	5165	Hushed Gray	1479	Stallion	1481
Champagne	1453	Irish Coffee	1444	Sweetwater Sage	1460
Coastal Nuance	5169	Liquid Silver	1440	Thunder Dusk	1495
Cocoa Nib	1484	Matte Plum	5162	Thyme	1489
Cornerstone	1478	Monsoon	1496	Timberwolf Gray	1445
Ebb & Flow	1491	Mulberry Grape	5164	Toasted Pecan	1485
Eggnog	1446	Natural Beige	5166	Tonal Taupe	5167
Elusive Gray	1474	Navy Charm	1466	Tuscan Red	1458
Endless Summer	5170	Nicoise	1490	Watermelon Punch	1498
Etched Stone	1499	Nostalgic Beige	1459	Whisper White	1441
Freshwater Pearl	1442	Penguin	1482		
Gentle Tan	1447	Pink Limestone	1497		
Glacier Bay	1493	Plebian Blue	1494		
Golden Wheat	1470	Powder Gray	1452		
Gray Dusk	5168	River Stone	1475		

\*Color coordinated with Splendor (light filtering)

<b>Sanctuary 3/4" Single Cell*</b>					
Arctic Lichen	1280	Gray Fedora	1255	Rose Colored Glass	1235
Arctic White	1251	Gray Moss	1288	Sandpiper	1277
Blanched Coral	1227	Harvested Wheat	1249	Shadow Frost	1292
Bourgogne	1237	Heather Mist	1234	Shell White	1261
Cabernet	1239	Hushed Gray	1279	Stallion	1281
Champagne	1253	Irish Coffee	1244	Sweetwater Sage	1260
Coastal Nuance	1297	Liquid Silver	1240	Thunder Dusk	1295
Cocoa Nib	1284	Matte Plum	1236	Thyme	1289
Cornerstone	1278	Monsoon	1230	Timberwolf Gray	1245
Ebb & Flow	1291	Mulberry Grape	1238	Toasted Pecan	1285
Eggnog	1246	Natural Beige	1228	Tonal Taupe	1229
Elusive Gray	1274	Navy Charm	1266	Tuscan Red	1258
Endless Summer	1298	Nicoise	1290	Watermelon Punch	1232
Etched Stone	1233	Nostalgic Beige	1259	Whisper White	1241
Freshwater Pearl	1242	Penguin	1282		
Gentle Tan	1247	Pink Limestone	1231		
Glacier Bay	1293	Plebian Blue	1294		
Golden Wheat	1270	Powder Gray	1252		
Gray Dusk	1296	River Stone	1275		

\*Color coordinated with Splendor (light filtering)

<b>Simply Sheer 3/4" Single Cell</b>					
Almond	2152	Steel Harbor	2155	Whisper	2150

<b>Splendor 1 1/4" Single Cell**</b>					
Arctic Lichen	0126	Navy Charm	4400	Timberwolf Gray	0128
Cornerstone	0124	River Stone	0129	Whisper White	0121
Freshwater Pearl	0127	Sandpiper	0123		
Liquid Silver	0120	Shell White	0122		

\*\*Color coordinated with Sanctuary (blackout)

**Price Group G: Couture Light Filtering ¾" (2.0 cm) Single Cell,  
Valletta ¾" (2.0 cm) Single Cell**

Height up to inches (cm) ↓	Width up to inches (cm) →																
	24 (61)	30 (76.2)	36 (91.5)	42 (106.7)	48 (122)	54 (137.2)	60 (152.4)	66 (167.7)	72 (182.9)	84 (213.4)	96 (243.9)	108 (274.4)	120 (304.8)	132 (335.3)	144 (365.8)	174 (442)	192 (487.7)
36 (91.5)	373	420	474	532	586	637	686	744	799	908	1170	1272	1373	1486	1593	1809	2342
42 (106.7)	402	448	519	577	637	695	754	817	875	1001	1272	1388	1516	1634	1757	2002	2545
48 (122)	426	488	554	624	686	754	821	895	957	1094	1373	1512	1641	1782	1915	2189	2745
54 (137.2)	455	521	595	667	744	815	892	965	1037	1188	1486	1625	1772	1933	2079	2374	2970
60 (152.4)	477	552	635	711	792	873	957	1037	1120	1284	1590	1753	1913	2079	2235	2574	3171
66 (167.7)	506	586	672	754	849	936	1026	1110	1200	1376	1696	1869	2054	2223	2398	2755	3396
72 (182.9)	532	614	711	808	908	1001	1093	1187	1283	1470	1807	2000	2183	2368	2563	2946	3615
78 (198.2)	555	649	748	849	958	1062	1161	1263	1365	1568	1918	2126	2319	2516	2726	3138	3828
84 (213.4)	577	680	786	895	1010	1123	1234	1336	1442	1656	2025	2253	2460	2676	2887	3310	4046
90 (228.6)	603	711	824	940	1070	1187	1298	1413	1527	1750	2139	2368	2594	2817	3034	3498	4273
96 (243.9)	632	746	866	987	1122	1251	1365	1486	1606	1846	2241	2497	2731	2970	3214	3690	4484
108 (274.4)	660	779	907	1033	1174	1319	1436	1561	1688	1947	2345	2621	2868	3120	3396	3886	4697
120 (304.8)	685	814	941	1083	1229	1384	1505	1633	1766	2044	2448	2749	3006	3270	3581	4078	4903
132 (335.3)	711	844	984	1127	1282	1452	1569	1707	1846	2142	2553	2877	3143	3422	3761	4271	5114
144 (365.8)	741	875	1023	1174	1333	1517	1639	1782	1926	2237	2654	3005	3280	3572	3943	4465	5319

NOTE: Cordless lift maximum height is 86" (218.5 cm). Cordless lift continuous shades available in outlined area above.

NOTE: Continuous width fabric up to 144" (365.8 cm).

<b>Couture Light Filtering ¾" Single Cell*</b>					
Feather White	0130	Noble Pewter	0133	Peaceful Gray	0135
Heron Plume	0131	Jute	0134		

\*Color coordinated with Couture Blackout

<b>Valletta ¾" Single Cell*</b>					
Coconut Cream	2851	Indigo Intrigue	0644	Stallion	0648
Crisp Carbon	0643	Manila	2852	Trevi	2857
Gourmet Chocolate	0646	Plebian Blue	0645		
Gray Moss	0647	Simply White	2850		

\*Color coordinated with Valletta Blackout

**Price Group H: Infuse Blackout 3/4" (2.0 cm) Single Cell, Kinsley Light Filtering  
3/4" (2.0 cm) Single Cell, Sanctuary 1 1/4" (3.2 cm) Single Cell, Valletta  
1 1/4" (3.2 cm) Single Cell**

Height up to inches (cm) ↓	Width up to inches (cm) →																
	24 (61)	30 (76.2)	36 (91.5)	42 (106.7)	48 (122)	54 (137.2)	60 (152.4)	66 (167.7)	72 (182.9)	84 (213.4)	96 (243.9)	108 (274.4)	120 (304.8)	132 (335.3)	144 (365.8)	174 (442)	192 (487.7)
36 (91.5)	435	490	553	622	679	741	801	866	927	1054	1361	1480	1596	1726	1852	2104	2722
42 (106.7)	470	524	598	670	741	809	878	953	1024	1166	1480	1617	1764	1901	2042	2326	2961
48 (122)	496	563	641	726	801	878	955	1041	1114	1275	1596	1757	1910	2075	2227	2548	3191
54 (137.2)	532	603	690	779	866	944	1034	1123	1210	1384	1726	1894	2063	2247	2417	2762	3454
60 (152.4)	555	638	737	829	923	1018	1114	1210	1301	1494	1846	2038	2225	2417	2600	2991	3684
66 (167.7)	593	679	783	878	987	1089	1195	1292	1396	1600	1973	2175	2389	2588	2792	3203	3952
72 (182.9)	622	719	829	938	1054	1166	1274	1381	1493	1710	2101	2324	2534	2755	2983	3426	4209
78 (198.2)	642	754	868	987	1115	1234	1348	1469	1590	1828	2228	2474	2697	2927	3172	3649	4457
84 (213.4)	670	791	917	1041	1174	1306	1433	1557	1680	1929	2357	2618	2863	3112	3356	3849	4707
90 (228.6)	702	829	959	1093	1247	1381	1507	1645	1777	2036	2489	2755	3018	3279	3530	4069	4973
96 (243.9)	733	867	1005	1148	1302	1458	1590	1726	1870	2147	2611	2900	3180	3454	3740	4294	5216
108 (274.4)	763	908	1052	1203	1364	1533	1667	1813	1962	2261	2730	3052	3339	3629	3952	4519	5457
120 (304.8)	800	943	1094	1257	1425	1607	1751	1898	2056	2377	2848	3196	3494	3803	4164	4746	5703
132 (335.3)	829	983	1143	1313	1488	1690	1829	1987	2147	2490	2971	3350	3657	3978	4377	4969	5949
144 (365.8)	864	1024	1188	1364	1552	1765	1907	2075	2241	2607	3089	3491	3814	4153	4586	5199	6190

NOTE: Cordless lift maximum height is 86" (218.5 cm). Cordless lift continuous shades available in outlined area above.

NOTE: Continuous width fabric up to 144" (365.8 cm).

NOTE: Fabric Wrapped Rails are available with the Sanctuary collection in cordless, continuous cord loop and motorized lift. See options pricing for surcharge.

Infuse Blackout 3/4" Single Cell*					
Aspen	3950	Indigo Intrigue	3954	Taupe Perfection	3958
Autumn Gold	3951	Rivermist	3955	Vanilla Cream	3959
Balanced Beige	3952	Savvy Slate	3956		
Ecru	3953	Subtle Sage	3957		

\*Color coordinated with Infuse Light Filtering

Kinsley Light Filtering 3/4" Single Cell*					
Aspen	0720	Indigo Intrigue	0727	Taupe Perfection	0728
Autumn Gold	0722	Rivermist	0729	Vanilla Cream	0724
Balanced Beige	0723	Savvy Slate	0725		
Ecru	0721	Subtle Sage	0726		

\*Color coordinated with Kinsley Blackout

Sanctuary 1 1/4" Single Cell*					
Arctic Lichen	0103	Navy Charm	0104	Timberwolf Gray	0106
Cornerstone	0108	River Stone	0107	Whisper White	0110
Freshwater Pearl	0105	Sandpiper	0112		
Liquid Silver	0109	Shell White	0111		

\*Color coordinated with Splendor (light filtering)

Valletta 1 1/4" Single Cell					
Coconut Cream	0662	Simply White	0660	Trevi	0661
Manila	0663	Stallion	0664		

\*Color coordinated with Valletta Blackout



**Price Group I: Couture Blackout ¾" (2.0 cm) Single Cell, Kinsley Blackout ¾" (2.0 cm) Single Cell**

Height up to inches (cm) ↓	Width up to inches (cm) →																	
	24 (61)	30 (76.2)	36 (91.5)	42 (106.7)	48 (122)	54 (137.2)	60 (152.4)	66 (167.7)	72 (182.9)	84 (213.4)	96 (243.9)	108 (274.4)	120 (304.8)	132 (335.3)	144 (365.8)	174 (442)	192 (487.7)	
36 (91.5)	545	611	693	776	850	929	1002	1083	1161	1319	1704	1850	1998	2160	2318	2634	3409	
42 (106.7)	589	656	749	840	929	1014	1102	1191	1282	1459	1850	2021	2210	2383	2556	2912	3706	
48 (122)	623	705	806	907	1002	1102	1195	1301	1393	1596	1998	2200	2388	2595	2788	3186	3994	
54 (137.2)	665	754	865	974	1083	1185	1296	1406	1515	1728	2160	2369	2582	2811	3023	3457	4325	
60 (152.4)	696	800	924	1037	1156	1273	1393	1515	1630	1870	2313	2551	2786	3023	3255	3744	4614	
66 (167.7)	740	850	981	1102	1236	1363	1495	1618	1748	2005	2470	2722	2991	3240	3495	4010	4948	
72 (182.9)	776	900	1037	1174	1319	1459	1594	1727	1868	2142	2630	2911	3176	3447	3735	4291	5269	
78 (198.2)	808	943	1086	1236	1395	1547	1687	1838	1987	2287	2789	3097	3377	3663	3972	4569	5582	
84 (213.4)	840	989	1148	1301	1471	1636	1794	1948	2103	2416	2952	3278	3585	3895	4203	4818	5896	
90 (228.6)	878	1037	1203	1369	1560	1727	1887	2057	2221	2550	3118	3447	3781	4104	4421	5097	6226	
96 (243.9)	920	1084	1259	1438	1631	1826	1987	2160	2343	2688	3270	3633	3979	4325	4682	5376	6532	
108 (274.4)	956	1135	1317	1505	1709	1919	2087	2271	2457	2832	3418	3821	4180	4543	4948	5659	6832	
120 (304.8)	1000	1183	1371	1573	1784	2015	2192	2378	2575	2977	3564	4002	4375	4760	5212	5941	7139	
132 (335.3)	1037	1230	1431	1644	1864	2113	2289	2489	2688	3120	3719	4192	4577	4981	5479	6222	7447	
144 (365.8)	1078	1282	1487	1709	1942	2211	2387	2595	2806	3259	3868	4373	4775	5202	5741	6505	7750	

**NOTE:** Cordless lift maximum height is 86" (218.5 cm). Cordless lift continuous shades available in outlined area above.  
**NOTE:** Continuous width fabric up to 144" (365.8 cm).

<b>Couture Blackout ¾" Single Cell</b>					
Feather White	1130	Jute	1134	Peaceful Gray	1135
Heron Plume	1131	Noble Pewter	1133		

\*Color coordinated with Couture Light Filtering

<b>Kinsley Blackout ¾" Single Cell</b>					
Aspen	1720	Indigo Intrigue	1727	Taupe Perfection	1728
Autumn Gold	1722	Rivermist	1729	Vanilla Cream	1724
Balanced Beige	1723	Savvy Slate	1725		
Ecran	1721	Subtle Sage	1726		

\*Color coordinated with Kinsley Light Filtering

**Price Group J: Champagne Toast 3/4" (2.0 cm) Single Cell, Valletta Blackout 3/4" (2.0 cm),  
Champagne Toast 1 1/4" (3.2 cm) Single Cell, Valletta Blackout 1 1/4" (3.2 cm)  
Single Cell**

Height up to inches (cm) ↓	Width up to inches (cm) →																
	24 (61)	30 (76.2)	36 (91.5)	42 (106.7)	48 (122)	54 (137.2)	60 (152.4)	66 (167.7)	72 (182.9)	84 (213.4)	96 (243.9)	108 (274.4)	120 (304.8)	132 (335.3)	144 (365.8)	174 (442)	192 (487.7)
36 (91.5)	612	688	779	873	956	1044	1126	1218	1306	1483	1916	2080	2247	2430	2607	2963	3834
42 (106.7)	662	737	843	944	1044	1141	1239	1339	1441	1640	2080	2274	2486	2681	2874	3276	4169
48 (122)	700	793	906	1020	1126	1239	1345	1463	1567	1795	2247	2474	2686	2920	3135	3585	4492
54 (137.2)	747	848	972	1094	1218	1332	1458	1582	1703	1943	2430	2665	2904	3163	3401	3888	4865
60 (152.4)	782	900	1040	1165	1299	1431	1567	1703	1834	2104	2601	2869	3134	3401	3661	4211	5190
66 (167.7)	832	956	1104	1239	1390	1533	1681	1819	1966	2255	2778	3062	3363	3645	3932	4511	5566
72 (182.9)	873	1012	1165	1320	1483	1640	1793	1942	2101	2410	2958	3275	3573	3877	4202	4827	5927
78 (198.2)	908	1059	1221	1390	1568	1739	1898	2068	2235	2572	3136	3483	3798	4120	4468	5139	6279
84 (213.4)	944	1113	1291	1463	1655	1839	2018	2191	2365	2717	3320	3687	4033	4381	4728	5419	6633
90 (228.6)	987	1165	1353	1539	1754	1942	2122	2314	2498	2867	3508	3877	4252	4616	4972	5733	7003
96 (243.9)	1035	1219	1417	1618	1835	2053	2235	2430	2635	3023	3678	4087	4476	4865	5267	6048	7347
108 (274.4)	1076	1276	1481	1693	1922	2158	2348	2554	2764	3185	3844	4298	4701	5110	5566	6366	7685
120 (304.8)	1123	1330	1541	1770	2007	2266	2466	2674	2897	3348	4008	4502	4921	5354	5863	6683	8031
132 (335.3)	1165	1384	1609	1849	2097	2377	2574	2800	3023	3510	4183	4715	5148	5603	6163	6998	8377
144 (365.8)	1212	1441	1672	1922	2184	2487	2685	2920	3156	3666	4351	4919	5371	5851	6458	7318	8718

**NOTE:** Cordless lift maximum height is 86" (218.5 cm). Cordless lift continuous shades available in outlined area above.

**NOTE:** Continuous width fabric up to 144" (365.8 cm).

**NOTE:** Fabric Wrapped Rails are available with the Champagne Toast collection in cordless, continuous cord loop and motorized lift. See options pricing for surch

Champagne Toast 3/4" Single Cell					
Baroque	2240	Nutmeg Gleam	2243	Thicket Gloss	2247
Elfin Woodland	2241	Piquant	2244	Wild Mink Shimmer	2249
Jet Black	2248	Pristine	2245		
Metallic Mauve	2242	Stonemired	2246		

Champagne Toast 1 1/4" Single Cell					
Baroque	4240	Nutmeg Gleam	4243	Thicket Gloss	4247
Elfin Woodland	4241	Piquant	4244	Wild Mink Shimmer	4249
Jet Black	4248	Pristine	4245		
Metallic Mauve	4242	Stonemired	4246		

Valletta Blackout 3/4" Single Cell*					
Coconut Cream	1020	Indigo Intrigue	1027	Stallion	1031
Crisp Carbon	1026	Manila	1021	Trevi	1024
Gourmet Chocolate	1029	Plebian Blue	1028		
Gray Moss	1030	Simply White	1022		

\*Color coordinated with Valletta (light filtering)

Valletta Blackout 1 1/4" Single Cell*					
Coconut Cream	3020	Simply White	3022	Trevi	3024
Manila	3021	Stallion	3031		

\*Color coordinated with Valletta (light filtering)

## Price Group K: Endeavor 3/4" (2.0 cm) Single Cell

### Graber Slide-Vue

Height up to inches (cm) ↓	Width up to inches (cm) →																		
	24 (61)	30 (76.2)	36 (91.5)	42 (106.7)	48 (122)	54 (137.2)	60 (152.4)	66 (167.7)	72 (182.9)	78 (198.2)	84 (213.4)	96 (243.9)	108 (274.4)	120 (304.8)	132 (335.3)	144 (365.8)	156 (396.3)	174 (442)	192 (487.7)
36 (91.5)	819	900	979	1055	1120	1180	1258	1328	1391	1492	1526	1652	1876	1959	2060	2141	2281	2298	2444
42 (106.7)	837	919	1005	1084	1147	1221	1296	1372	1438	1541	1582	1697	1942	2042	2149	2235	2391	2403	2543
48 (122)	849	939	1024	1110	1180	1256	1334	1415	1485	1600	1636	1780	2014	2118	2233	2330	2505	2520	2706
54 (137.2)	865	954	1055	1138	1210	1288	1371	1454	1533	1653	1687	1839	2082	2193	2319	2422	2613	2621	2833
60 (152.4)	879	978	1070	1160	1243	1319	1416	1499	1584	1712	1745	1911	2152	2276	2403	2513	2728	2734	2960
66 (167.7)	900	1001	1100	1188	1272	1358	1452	1543	1628	1767	1802	1972	2221	2353	2491	2613	2835	2846	3090
72 (182.9)	908	1012	1120	1221	1311	1393	1492	1587	1674	1826	1856	2036	2302	2433	2573	2706	2947	2957	3215
78 (198.2)	922	1035	1144	1243	1336	1431	1532	1636	1725	1878	1913	2100	2375	2511	2667	2808	3057	3066	3349
84 (213.4)	938	1049	1167	1265	1372	1472	1573	1675	1775	1929	1962	2163	2445	2596	2756	2897	3156	3169	3475
90 (228.6)	952	1069	1188	1290	1402	1503	1612	1720	1816	1984	2015	2233	2513	2674	2837	2996	3268	3277	3600
96 (243.9)	971	1091	1209	1319	1437	1538	1653	1765	1865	2041	2074	2293	2591	2757	2930	3090	3380	3390	3730
108 (274.4)	990	1119	1243	1360	1480	1588	1713	1826	1937	2121	2151	2382	2684	2867	3052	3224	3531	3545	3900
120 (304.8)	1029	1166	1299	1420	1551	1669	1798	1918	2039	2243	2276	2525	2835	3036	3242	3425	3772	3782	4176

Endeavor 3/4" Single Cell*					
Elegant Dove	0374	Pier	0378	White Radish	0381
Llama	0377	Thickened Cream	0380		

\*Color coordinated with Discovery (blackout)

## Price Group L: Splendor 3/4" (2.0 cm) Single Cell

### Graber Slide-Vue

Height up to inches (cm) ↓	Width up to inches (cm) →																		
	24 (61)	30 (76.2)	36 (91.5)	42 (106.7)	48 (122)	54 (137.2)	60 (152.4)	66 (167.7)	72 (182.9)	78 (198.2)	84 (213.4)	96 (243.9)	108 (274.4)	120 (304.8)	132 (335.3)	144 (365.8)	156 (396.3)	174 (442)	192 (487.7)
36 (91.5)	846	922	1012	1095	1163	1231	1313	1389	1461	1573	1601	1745	1997	2101	2213	2310	2485	2497	2686
42 (106.7)	857	951	1041	1124	1203	1276	1361	1439	1521	1642	1675	1805	2087	2206	2325	2432	2627	2638	2807
48 (122)	876	978	1070	1158	1244	1325	1410	1497	1583	1711	1744	1904	2180	2297	2432	2547	2765	2777	3003
54 (137.2)	903	1000	1101	1192	1277	1361	1455	1554	1636	1778	1808	1985	2264	2395	2539	2664	2901	2914	3165
60 (152.4)	917	1021	1132	1227	1319	1412	1512	1602	1696	1850	1882	2070	2353	2497	2647	2788	3043	3055	3330
66 (167.7)	937	1047	1157	1258	1358	1453	1562	1663	1757	1916	1948	2149	2444	2598	2754	2910	3180	3191	3489
72 (182.9)	955	1074	1189	1298	1398	1498	1605	1712	1817	1993	2020	2231	2535	2695	2862	3023	3318	3330	3649
78 (198.2)	976	1095	1214	1329	1439	1543	1659	1772	1877	2060	2091	2310	2636	2794	2978	3146	3463	3474	3814
84 (213.4)	990	1117	1245	1357	1480	1594	1711	1829	1938	2123	2155	2390	2723	2901	3094	3267	3584	3600	3972
90 (228.6)	1011	1143	1272	1394	1523	1636	1763	1881	1996	2190	2229	2474	2808	3002	3199	3380	3729	3736	4136
96 (243.9)	1027	1166	1303	1430	1561	1684	1808	1938	2057	2264	2295	2554	2907	3103	3309	3502	3870	3879	4297
108 (274.4)	1049	1194	1336	1473	1605	1736	1876	2004	2132	2352	2381	2652	3011	3225	3444	3657	4041	4059	4496
120 (304.8)	1090	1246	1398	1537	1684	1827	1970	2106	2247	2486	2522	2808	3182	3415	3661	3879	4318	4330	4811

Splendor 3/4" Single Cell*					
Arctic Lichen	1381	Gray Fedora	1338	Rose Colored Glass	1395
Arctic White	1333	Gray Moss	1382	Sandpiper	1371
Blanched Coral	1374	Harvested Wheat	1331	Shadow Frost	1386
Bourgogne	1397	Heather Mist	1394	Shell White	1345
Cabernet	1399	Hushed Gray	1373	Stallion	1375
Champagne	1336	Irish Coffee	1324	Sweetwater Sage	1344
Coastal Nuance	1357	Liquid Silver	1320	Thunder Dusk	1389
Cocoa Nib	1378	Matte Plum	1396	Thyme	1383
Cornerstone	1372	Monsoon	1390	Timberwolf Gray	1325
Ebb & Flow	1385	Mulberry Grape	1398	Toasted Pecan	1379
Eggnog	1328	Natural Beige	1326	Tonal Taupe	1363
Elusive Gray	1367	Navy Charm	1351	Tuscan Red	1342
Endless Summer	1356	Nicoise	1384	Watermelon Punch	1392
Etched Stone	1393	Nostalgic Beige	1343	Whisper White	1321
Freshwater Pearl	1322	Penguin	1376		
Gentle Tan	1329	Pink Limestone	1391		
Glacier Bay	1387	Plebian Blue	1388		
Golden Wheat	1355	Powder Gray	1334		
Gray Dusk	1335	River Stone	1368		

\*Color coordinated with Sanctuary (blackout).

**Price Group M: Splendor 1/2" (1.3 cm) Double Cell, Enchantment Light Filtering 3/4" (2.0 cm) Single Cell, Montage Light Filtering 3/4" (2.0 cm) Single Cell, Prestige Light Filtering 3/4" (2.0 cm) Single Cell**

**Graber Slide-Vue**

Height up to inches (cm) ↓	Width up to inches (cm) →																		
	24 (61)	30 (76.2)	36 (91.5)	42 (106.7)	48 (122)	54 (137.2)	60 (152.4)	66 (167.7)	72 (182.9)	78 (198.2)	84 (213.4)	96 (243.9)	108 (274.4)	120 (304.8)	132 (335.3)	144 (365.8)	156 (396.3)	174 (442)	192 (487.7)
36 (91.5)	869	952	1044	1132	1209	1277	1364	1447	1520	1644	1672	1825	2103	2212	2326	2439	2630	2643	2853
42 (106.7)	890	984	1080	1172	1245	1327	1421	1505	1588	1719	1751	1885	2201	2326	2451	2568	2789	2799	2984
48 (122)	908	1012	1112	1206	1292	1380	1471	1565	1653	1794	1827	2004	2302	2432	2572	2706	2947	2956	3213
54 (137.2)	934	1038	1144	1245	1336	1427	1523	1629	1715	1874	1904	2099	2395	2539	2701	2831	3098	3111	3385
60 (152.4)	949	1060	1176	1279	1380	1475	1583	1681	1785	1955	1983	2186	2497	2658	2817	2969	3256	3268	3573
66 (167.7)	973	1095	1211	1321	1425	1525	1645	1751	1857	2028	2060	2273	2596	2771	2942	3104	3409	3420	3749
72 (182.9)	1000	1118	1244	1366	1470	1579	1691	1805	1919	2108	2139	2366	2701	2871	3060	3237	3566	3577	3931
78 (198.2)	1018	1143	1273	1394	1520	1630	1751	1873	1983	2186	2216	2456	2806	2983	3183	3372	3723	3734	4116
84 (213.4)	1038	1169	1302	1427	1559	1680	1809	1936	2054	2261	2293	2543	2903	3107	3320	3506	3867	3876	4290
90 (228.6)	1053	1199	1336	1466	1609	1727	1865	1995	2122	2334	2366	2635	3002	3220	3429	3635	4017	4027	4476
96 (243.9)	1075	1227	1367	1508	1652	1780	1924	2054	2186	2415	2450	2728	3107	3328	3554	3772	4180	4185	4658
108 (274.4)	1101	1258	1412	1556	1703	1847	1993	2132	2271	2513	2547	2834	3231	3470	3710	3940	4372	4384	4882
120 (304.8)	1144	1313	1475	1630	1790	1944	2100	2248	2398	2665	2701	3013	3421	3681	3947	4196	4681	4693	5227

<b>Splendor 1/2" Double Cell*</b>					
Arctic Lichen	1517	Gray Fedora	1538	Rose Colored Glass	1585
Arctic White	1533	Gray Moss	1518	Sandpiper	1571
Blanched Coral	1590	Harvested Wheat	1531	Shadow Frost	1576
Bourgoigne	1587	Heather Mist	1584	Shell White	1545
Cabernet	1589	Hushed Gray	1573	Stallion	1591
Champagne	1536	Irish Coffee	1524	Sweetwater Sage	1544
Coastal Nuance	1557	Liquid Silver	1520	Thunder Dusk	1579
Cocoa Nib	1514	Matte Plum	1586	Thyme	1519
Cornerstone	1572	Monsoon	1580	Timberwolf Gray	1525
Ebb & Flow	1575	Mulberry Grape	1588	Toasted Pecan	1515
Eggnog	1528	Natural Beige	1526	Tonal Taupe	1563
Elusive Gray	1567	Navy Charm	1551	Tuscan Red	1542
Endless Summer	1556	Nicoise	1574	Watermelon Punch	1582
Etched Stone	1583	Nostalgic Beige	1543	Whisper White	1521
Freshwater Pearl	1522	Penguin	1512		
Gentle Tan	1529	Pink Limestone	1581		
Glacier Bay	1577	Plebian Blue	1578		
Golden Wheat	1555	Powder Gray	1534		
Gray Dusk	1535	River Stone	1568		

\*Color coordinated with Sanctuary (blackout).

<b>Enchantment Light Filtering 3/4" Single Cell</b>					
Genteel Beige	0620	Silver Shadow	0622	Ridged Sand	0624
Regal Gray	0621	Glacial Gray	0623		

\*Color coordinated with Enchantment Blackout

<b>Montage Light Filtering 3/4" Single Cell</b>					
Gray Granite	0610	Gray Moon	0612	Gray Hues	0614
Cultivated Khaki	0611	Chroma Gray	0613		

\*Color coordinated with Montage Blackout

<b>Prestige Light Filtering 3/4" Single Cell</b>					
Beige Influence	0590	Refined Flax	0592	Gray Juniper	0594
Sophisticated Stone	0591	Pale Pebble	0593		

\*Color coordinated with Prestige Blackout

**Price Group N: Discovery 3/4" (2.0 cm) Single Cell, Scroll FR 3/4" (2.0 cm) Single Cell**

**Graber Slide-Vue**

Height up to inches (cm) ↓	Width up to inches (cm) →																		
	24 (61)	30 (76.2)	36 (91.5)	42 (106.7)	48 (122)	54 (137.2)	60 (152.4)	66 (167.7)	72 (182.9)	78 (198.2)	84 (213.4)	96 (243.9)	108 (274.4)	120 (304.8)	132 (335.3)	144 (365.8)	156 (396.3)	174 (442)	192 (487.7)
36 (91.5)	919	1009	1102	1194	1269	1342	1430	1516	1594	1720	1746	1906	2180	2292	2415	2520	2712	2724	2931
42 (106.7)	938	1036	1140	1230	1313	1393	1484	1571	1661	1792	1829	1970	2280	2407	2535	2653	2866	2879	3061
48 (122)	956	1068	1167	1262	1356	1444	1534	1632	1725	1865	1904	2078	2378	2505	2653	2780	3018	3033	3277
54 (137.2)	983	1090	1201	1303	1394	1484	1589	1692	1783	1941	1972	2167	2471	2615	2773	2909	3165	3180	3455
60 (152.4)	1001	1113	1233	1338	1439	1536	1650	1747	1850	2019	2055	2258	2568	2724	2889	3040	3322	3330	3632
66 (167.7)	1021	1144	1261	1373	1481	1587	1702	1813	1915	2093	2126	2345	2664	2835	3005	3171	3470	3483	3806
72 (182.9)	1043	1171	1299	1415	1527	1633	1751	1867	1983	2172	2207	2433	2766	2942	3126	3299	3623	3632	3980
78 (198.2)	1063	1194	1326	1450	1571	1685	1809	1937	2049	2245	2282	2520	2876	3048	3249	3430	3775	3792	4163
84 (213.4)	1081	1216	1357	1480	1616	1740	1865	1995	2112	2319	2350	2602	2971	3165	3377	3564	3912	3928	4333
90 (228.6)	1101	1246	1390	1521	1663	1783	1918	2054	2178	2393	2429	2699	3062	3276	3488	3690	4066	4077	4513
96 (243.9)	1120	1270	1420	1561	1701	1836	1972	2112	2242	2471	2503	2786	3169	3383	3607	3822	4225	4236	4688
108 (274.4)	1145	1304	1461	1605	1751	1896	2046	2185	2327	2565	2599	2892	3283	3519	3761	3988	4412	4422	4907
120 (304.8)	1190	1358	1527	1677	1836	1993	2146	2299	2451	2716	2751	3062	3472	3730	3993	4236	4714	4724	5248

**Discovery 3/4" Single Cell\***

Elegant Dove	0191	Pier	0194	White Radish	0195
Llama	0193	Thickened Cream	0212		

\*Color coordinated with Endeavor (light filtering).

**Scroll FR 3/4" Single Cell\***

Adirondack	2916	Simply White	2901	Trevi	2918
Manila	2914	Spring Fawn	2915		

**Price Group O: Enchantment Blackout 3/4" (2.0 cm) Single Cell, Infuse Light Filtering 3/4" (2.0 cm) Single Cell, Montage Blackout 3/4" (2.0 cm) Single Cell, Prestige Blackout 3/4" (2.0 cm) Single Cell, Sanctuary 3/4" (2.0 cm) Single Cell, Sanctuary 1/2" (1.3 cm) Double Cell, Splendor 1/4" (3.2 cm) Single Cell**

**Graber Slide-Vue**

Height up to inches (cm) ↓	Width up to inches (cm) →																		
	24 (61)	30 (76.2)	36 (91.5)	42 (106.7)	48 (122)	54 (137.2)	60 (152.4)	66 (167.7)	72 (182.9)	78 (198.2)	84 (213.4)	96 (243.9)	108 (274.4)	120 (304.8)	132 (335.3)	144 (365.8)	156 (396.3)	174 (442)	192 (487.7)
36 (91.5)	922	1015	1110	1203	1276	1350	1438	1522	1602	1727	1757	2062	2230	2353	2494	2617	2844	2854	3391
42 (106.7)	943	1042	1144	1234	1318	1401	1496	1583	1669	1815	1847	2162	2348	2495	2643	2780	3035	3045	3599
48 (122)	963	1074	1175	1270	1361	1452	1543	1652	1743	1908	1938	2264	2471	2621	2790	2934	3220	3234	3796
54 (137.2)	986	1096	1208	1311	1402	1500	1611	1725	1825	1999	2028	2375	2585	2750	2936	3094	3408	3415	4020
60 (152.4)	1006	1120	1243	1347	1452	1563	1680	1794	1904	2100	2125	2475	2706	2890	3080	3253	3599	3605	4219
66 (167.7)	1027	1148	1270	1389	1506	1622	1748	1867	1985	2188	2218	2586	2825	3027	3225	3415	3781	3792	4444
72 (182.9)	1049	1176	1310	1438	1564	1686	1815	1941	2066	2286	2312	2695	2954	3157	3373	3581	3970	3979	4663
78 (198.2)	1068	1204	1346	1481	1618	1748	1879	2019	2150	2379	2409	2806	3080	3290	3516	3744	4161	4170	4877
84 (213.4)	1087	1232	1384	1523	1669	1809	1952	2091	2228	2468	2495	2913	3203	3435	3673	3897	4332	4342	5094
90 (228.6)	1112	1267	1423	1568	1726	1870	2019	2165	2308	2559	2586	3023	3320	3568	3818	4044	4519	4532	5316
96 (243.9)	1132	1296	1462	1617	1783	1940	2091	2252	2400	2664	2689	3145	3460	3720	3980	4227	4740	4747	5562
108 (274.4)	1152	1328	1503	1662	1839	2006	2173	2331	2485	2763	2788	3266	3599	3883	4159	4401	4936	4942	5808
120 (304.8)	1212	1364	1545	1713	1904	2071	2245	2413	2574	2864	2889	3387	3732	4036	4319	4566	5148	5159	6064

<b>Enchantment Blackout 3/4" Single Cell*</b>					
Genteel Beige	0625	Regal Gray	0627	Silver Shadow	0629
Glacial Gray	0626	Ridged Sand	0628		

\*Color coordinated with Enchantment Light Filtering

<b>Infuse Light Filtering 3/4" Single Cell*</b>					
Aspen	0950	Indigo Intrigue	0954	Taupe Perfection	0958
Autumn Gold	0951	Rivermist	0955	Vanilla Cream	0959
Balanced Beige	0952	Savvy Slate	0956		
Ecru	0953	Subtle Sage	0957		

\*Color coordinated with Infuse Blackout

<b>Montage Blackout 3/4" Single Cell*</b>					
Chroma Gray	0615	Gray Granite	0617	Gray Moon	0619
Cultivated Khaki	0616	Gray Hues	0618		

\*Color coordinated with Montage Light Filtering

<b>Prestige Blackout 3/4" Single Cell*</b>					
Beige Influence	0595	Pale Pebble	0597	Sophisticated Stone	0599
Gray Juniper	0596	Refined Flax	0598		

\*Color coordinated with Prestige Light Filtering

<b>Sanctuary 1/2" Double Cell*</b>					
Arctic Lichen	1487	Gray Fedora	1455	Rose Colored Glass	5161
Arctic White	1451	Gray Moss	1488	Sandpiper	1477
Blanched Coral	1480	Harvested Wheat	1449	Shadow Frost	1492
Bourgogne	5163	Heather Mist	5160	Shell White	1461
Cabernet	5165	Hushed Gray	1479	Stallion	1481
Champagne	1453	Irish Coffee	1444	Sweetwater Sage	1460
Coastal Nuance	5169	Liquid Silver	1440	Thunder Dusk	1495
Cocoa Nib	1484	Matte Plum	5162	Thyme	1489
Cornerstone	1478	Monsoon	1496	Timberwolf Gray	1445
Ebb & Flow	1491	Mulberry Grape	5164	Toasted Pecan	1485
Eggnog	1446	Natural Beige	5166	Tonal Taupe	5167
Elusive Gray	1474	Navy Charm	1466	Tuscan Red	1458
Endless Summer	5170	Nicoise	1490	Watermelon Punch	1498
Etched Stone	1499	Nostalgic Beige	1459	Whisper White	1441
Freshwater Pearl	1442	Penguin	1482		
Gentle Tan	1447	Pink Limestone	1497		
Glacier Bay	1493	Plebian Blue	1494		
Golden Wheat	1470	Powder Gray	1452		
Gray Dusk	5168	River Stone	1475		

\*Color coordinated with Splendor (light filtering).

<b>Sanctuary 3/4" Single Cell*</b>					
Arctic Lichen	1280	Gray Fedora	1255	Rose Colored Glass	1235
Arctic White	1251	Gray Moss	1288	Sandpiper	1277
Blanched Coral	1227	Harvested Wheat	1249	Shadow Frost	1292
Bourgogne	1237	Heather Mist	1234	Shell White	1261
Cabernet	1239	Hushed Gray	1279	Stallion	1281
Champagne	1253	Irish Coffee	1244	Sweetwater Sage	1260
Coastal Nuance	1297	Liquid Silver	1240	Thunder Dusk	1295
Cocoa Nib	1284	Matte Plum	1236	Thyme	1289
Cornerstone	1278	Monsoon	1230	Timberwolf Gray	1245
Ebb & Flow	1291	Mulberry Grape	1238	Toasted Pecan	1285
Eggnog	1246	Natural Beige	1228	Tonal Taupe	1229
Elusive Gray	1274	Navy Charm	1266	Tuscan Red	1258
Endless Summer	1298	Nicoise	1290	Watermelon Punch	1232
Etched Stone	1233	Nostalgic Beige	1259	Whisper White	1241
Freshwater Pearl	1242	Penguin	1282		
Gentle Tan	1247	Pink Limestone	1231		
Glacier Bay	1293	Plebian Blue	1294		
Golden Wheat	1270	Powder Gray	1252		
Gray Dusk	1296	River Stone	1275		

\*Color coordinated with Splendor (light filtering).

<b>Splendor 1 1/4" Single Cell**</b>					
Arctic Lichen	0126	Navy Charm	4400	Timberwolf Gray	0128
Cornerstone	0124	River Stone	0129	Whisper White	0121
Freshwater Pearl	0127	Sandpiper	0123		
Liquid Silver	0120	Shell White	0122		

\*\*Color coordinated with Sanctuary (blackout).



**Price Group P: Couture Light Filtering 3/4" (2.0 cm) Single Cell, Simply Sheer  
3/4" (2.0 cm) Single Cell, Valletta 3/4" (2.0 cm) Single Cell**

**Grabex Slide-View**

Height up to inches (cm) ↓	Width up to inches (cm) →																		
	24 (61)	30 (76.2)	36 (91.5)	42 (106.7)	48 (122)	54 (137.2)	60 (152.4)	66 (167.7)	72 (182.9)	78 (198.2)	84 (213.4)	96 (243.9)	108 (274.4)	120 (304.8)	132 (335.3)	144 (365.8)	156 (396.3)	174 (442)	192 (487.7)
36 (91.5)	944	1045	1115	1209	1291	1373	1462	1557	1639	1780	1810	2133	2309	2436	2584	2706	2943	2954	3512
42 (106.7)	955	1075	1154	1251	1345	1431	1533	1632	1726	1880	1911	2237	2429	2585	2735	2879	3143	3152	3726
48 (122)	972	1077	1191	1300	1394	1495	1597	1709	1804	1974	2006	2345	2558	2712	2889	3039	3333	3349	3932
54 (137.2)	1000	1115	1232	1346	1453	1556	1669	1787	1885	2071	2101	2459	2673	2846	3040	3205	3527	3536	4159
60 (152.4)	1026	1145	1273	1392	1502	1619	1741	1859	1972	2174	2205	2562	2802	2992	3186	3370	3726	3735	4366
66 (167.7)	1054	1180	1315	1435	1562	1680	1810	1933	2054	2265	2295	2674	2922	3137	3343	3536	3911	3927	4603
72 (182.9)	1077	1212	1355	1492	1620	1745	1880	2012	2140	2367	2393	2794	3058	3268	3490	3708	4113	4120	4827
78 (198.2)	1100	1246	1393	1533	1674	1810	1946	2091	2228	2463	2492	2901	3186	3408	3641	3875	4307	4317	5050
84 (213.4)	1124	1274	1431	1582	1729	1873	2020	2165	2307	2557	2585	3016	3316	3555	3804	4036	4484	4496	5271
90 (228.6)	1152	1313	1474	1625	1789	1936	2091	2241	2390	2647	2674	3129	3440	3693	3954	4188	4680	4690	5504
96 (243.9)	1180	1345	1516	1674	1844	1999	2157	2320	2475	2743	2772	3244	3562	3830	4098	4342	4874	4887	5742
108 (274.4)	1210	1380	1556	1725	1904	2057	2228	2398	2562	2835	2865	3358	3687	3972	4248	4501	5067	5089	5976
120 (304.8)	1236	1413	1591	1769	1962	2122	2295	2479	2647	2934	2964	3474	3809	4113	4393	4654	5266	5282	6209

**Couture Light Filtering 3/4" Single Cell\***

Feather White	0130	Noble Pewter	0133	Peaceful Gray	0135
Heron Plume	0131	Jute	0134		

\*Color coordinated with Couture Blackout

**Simply Sheer 3/4" Single Cell**

Almond	2152	Steel Harbor	2155	Whisper	2150
--------	------	--------------	------	---------	------

**Valletta 3/4" Single Cell\***

Coconut Cream	2851	Indigo Intrigue	0644	Stallion	0648
Crisp Carbon	0643	Manila	2852	Trevi	2857
Gourmet Chocolate	0646	Plebian Blue	0645		
Gray Moss	0647	Simply White	2850		

\*Color coordinated with Valletta Blackout

**Price Group Q: Infuse Blackout 3/4" (2.0 cm) Single Cell, Kinsley Light Filtering  
3/4" (2.0 cm) Single Cell, Sanctuary 1 1/4" (3.2 cm) Single Cell, Valletta  
1 1/4" (3.2 cm) Single Cell**

**Graber Slide-Vue**

Height up to inches (cm) ↓	Width up to inches (cm) →																		
	24 (61)	30 (76.2)	36 (91.5)	42 (106.7)	48 (122)	54 (137.2)	60 (152.4)	66 (167.7)	72 (182.9)	78 (198.2)	84 (213.4)	96 (243.9)	108 (274.4)	120 (304.8)	132 (335.3)	144 (365.8)	156 (396.3)	174 (442)	192 (487.7)
36 (91.5)	1067	1176	1296	1403	1500	1597	1700	1810	1908	2074	2108	2481	2684	2834	3001	3148	3421	3437	4088
42 (106.7)	1100	1209	1342	1455	1563	1667	1785	1899	2008	2187	2220	2599	2826	3003	3183	3350	3652	3667	4332
48 (122)	1126	1255	1389	1512	1624	1740	1858	1990	2099	2296	2333	2728	2975	3157	3360	3534	3878	3894	4575
54 (137.2)	1162	1296	1434	1565	1689	1808	1941	2076	2194	2409	2444	2860	3111	3309	3538	3729	4103	4115	4840
60 (152.4)	1191	1333	1482	1619	1748	1881	2021	2162	2293	2530	2562	2980	3261	3480	3706	3923	4332	4347	5078
66 (167.7)	1225	1371	1532	1670	1816	1953	2108	2251	2392	2639	2670	3114	3401	3649	3887	4115	4554	4565	5351
72 (182.9)	1255	1412	1574	1734	1885	2032	2187	2339	2491	2753	2786	3245	3558	3803	4063	4313	4780	4793	5616
78 (198.2)	1279	1450	1620	1785	1949	2108	2265	2434	2590	2866	2899	3377	3706	3964	4236	4509	5011	5022	5874
84 (213.4)	1308	1483	1667	1836	2013	2178	2352	2520	2678	2973	3003	3508	3854	4134	4426	4691	5218	5231	6130
90 (228.6)	1339	1527	1715	1892	2078	2252	2434	2606	2777	3081	3114	3644	4001	4297	4598	4872	5441	5457	6405
96 (243.9)	1371	1563	1761	1949	2146	2325	2511	2700	2879	3190	3222	3773	4144	4454	4769	5054	5675	5685	6681
108 (274.4)	1406	1605	1808	2007	2213	2395	2590	2791	2980	3302	3332	3908	4290	4619	4940	5233	5898	5918	6953
120 (304.8)	1438	1645	1854	2057	2281	2468	2670	2882	3081	3411	3445	4042	4435	4780	5109	5413	6126	6144	7225

<b>Infuse Blackout 3/4" Single Cell*</b>					
Aspen	3950	Indigo Intrigue	3954	Taupe Perfection	3958
Autumn Gold	3951	Rivermist	3955	Vanilla Cream	3959
Balanced Beige	3952	Savvy Slate	3956		
Ecru	3953	Subtle Sage	3957		

\*Color coordinated with Infuse Light Filtering

<b>Kinsley Light Filtering 3/4" Single Cell*</b>					
Aspen	0720	Indigo Intrigue	0727	Taupe Perfection	0728
Autumn Gold	0722	Rivermist	0729	Vanilla Cream	0724
Balanced Beige	0723	Savvy Slate	0725		
Ecru	0721	Subtle Sage	0726		

\*Color coordinated with Kinsley Blackout

<b>Sanctuary 1 1/4" Single Cell*</b>					
Arctic Lichen	0103	Navy Charm	0104	Timberwolf Gray	0106
Cornerstone	0108	River Stone	0107	Whisper White	0110
Freshwater Pearl	0105	Sandpiper	0112		
Liquid Silver	0109	Shell White	0111		

\*Color coordinated with Splendor (light filtering).

<b>Valletta 1 1/4" Single Cell*</b>					
Coconut Cream	0662	Simply White	0660	Trevi	0661
Manila	0663	Stallion	0664		

\*Color coordinated with Valletta Blackout

**Price Group R: Couture Blackout 3/4" (2.0 cm) Single Cell, Kinsley Blackout 3/4" (2.0 cm) Single Cell**

**Graber Slide-Vue**

Height up to inches (cm) ↓	Width up to inches (cm) →																		
	24 (61)	30 (76.2)	36 (91.5)	42 (106.7)	48 (122)	54 (137.2)	60 (152.4)	66 (167.7)	72 (182.9)	78 (198.2)	84 (213.4)	96 (243.9)	108 (274.4)	120 (304.8)	132 (335.3)	144 (365.8)	156 (396.3)	174 (442)	192 (487.7)
36 (91.5)	1335	1472	1623	1757	1879	2001	2128	2266	2389	2596	2639	3106	3358	3547	3758	3941	4284	4302	5118
42 (106.7)	1378	1515	1681	1824	1956	2086	2234	2378	2514	2739	2783	3254	3538	3762	3985	4192	4575	4592	5424
48 (122)	1412	1568	1736	1892	2033	2175	2327	2492	2627	2874	2921	3414	3724	3953	4210	4422	4857	4873	5724
54 (137.2)	1454	1623	1793	1961	2115	2264	2429	2599	2749	3014	3060	3582	3894	4144	4428	4666	5137	5152	6061
60 (152.4)	1493	1668	1856	2027	2189	2356	2533	2706	2869	3165	3207	3732	4082	4355	4639	4911	5424	5442	6361
66 (167.7)	1532	1719	1917	2091	2274	2446	2639	2819	2994	3304	3343	3897	4256	4569	4865	5152	5702	5717	6700
72 (182.9)	1568	1766	1973	2171	2360	2542	2739	2928	3118	3447	3483	4064	4454	4762	5086	5400	5983	6001	7029
78 (198.2)	1601	1814	2028	2234	2441	2639	2835	3046	3242	3588	3629	4227	4639	4963	5303	5644	6274	6288	7355
84 (213.4)	1638	1857	2086	2299	2520	2728	2945	3154	3354	3721	3762	4391	4826	5175	5542	5874	6534	6548	7675
90 (228.6)	1679	1912	2148	2368	2601	2820	3046	3264	3478	3856	3897	4559	5009	5380	5754	6100	6812	6832	8019
96 (243.9)	1719	1956	2203	2441	2687	2911	3143	3379	3602	3995	4036	4724	5188	5578	5971	6326	7102	7119	8362
108 (274.4)	1759	2010	2264	2512	2772	3000	3242	3494	3732	4132	4170	4893	5370	5782	6185	6551	7385	7410	8703
120 (304.8)	1800	2059	2320	2574	2856	3090	3343	3608	3856	4269	4314	5062	5551	5983	6398	6777	7667	7694	9048

<b>Couture Blackout 3/4" Single Cell</b>					
Feather White	1130	Jute	1134	Peaceful Gray	1135
Heron Plume	1131	Noble Pewter	1133		

\*Color coordinated with Couture Light Filtering

<b>Kinsley Blackout 3/4" Single Cell</b>					
Aspen	1720	Indigo Intrigue	1727	Taupe Perfection	1728
Autumn Gold	1722	Rivermist	1729	Vanilla Cream	1724
Balanced Beige	1723	Savvy Slate	1725		
Ecru	1721	Subtle Sage	1726		

\*Color coordinated with Kinsley Light Filtering

**Price Group S: Champagne Toast 3/4" (2.0 cm) Single Cell, Valletta Blackout 3/4" (2.0 cm),  
 Champagne Toast 1 1/4" (3.2 cm) Single Cell, Valletta Blackout 1 1/4" (3.2 cm)  
 Single Cell**

**Graber Slide-Vue**

Height up to inches (cm) ↓	Width up to inches (cm) →																		
	24 (61)	30 (76.2)	36 (91.5)	42 (106.7)	48 (122)	54 (137.2)	60 (152.4)	66 (167.7)	72 (182.9)	78 (198.2)	84 (213.4)	96 (243.9)	108 (274.4)	120 (304.8)	132 (335.3)	144 (365.8)	156 (396.3)	174 (442)	192 (487.7)
36 (91.5)	1535	1693	1866	2020	2161	2300	2448	2606	2748	2985	3035	3572	3862	4078	4321	4532	4927	4947	5885
42 (106.7)	1585	1742	1934	2098	2250	2399	2568	2734	2891	3150	3200	3742	4068	4326	4582	4820	5261	5281	6238
48 (122)	1624	1803	1997	2175	2338	2501	2676	2866	3021	3306	3358	3926	4282	4546	4841	5086	5585	5605	6583
54 (137.2)	1672	1866	2062	2254	2432	2604	2794	2989	3161	3466	3519	4119	4478	4765	5093	5367	5908	5924	6971
60 (152.4)	1716	1918	2134	2330	2518	2709	2913	3112	3300	3639	3688	4291	4694	5008	5334	5647	6238	6258	7315
66 (167.7)	1762	1976	2205	2406	2615	2812	3035	3241	3443	3799	3844	4481	4895	5253	5594	5924	6556	6575	7705
72 (182.9)	1803	2031	2269	2496	2715	2923	3150	3367	3586	3964	4005	4674	5123	5476	5849	6209	6880	6901	8084
78 (198.2)	1841	2086	2331	2568	2806	3035	3260	3504	3728	4126	4173	4860	5334	5708	6098	6491	7216	7231	8458
84 (213.4)	1884	2135	2399	2645	2898	3137	3387	3627	3857	4279	4326	5050	5550	5952	6373	6754	7513	7531	8827
90 (228.6)	1932	2199	2470	2724	2992	3243	3504	3753	3999	4434	4481	5243	5760	6187	6617	7015	7834	7857	9222
96 (243.9)	1976	2250	2533	2806	3089	3348	3615	3886	4143	4594	4642	5433	5965	6414	6868	7274	8167	8187	9617
108 (274.4)	2022	2312	2604	2889	3188	3450	3728	4019	4291	4752	4795	5627	6175	6649	7113	7534	8492	8522	10008
120 (304.8)	2070	2368	2668	2961	3284	3554	3844	4148	4434	4909	4961	5821	6383	6880	7358	7793	8816	8847	10406

<b>Champagne Toast 3/4" Single Cell</b>				
Baroque	2240	Nutmeg Gleam	2243	Thicket Gloss 2247
Elfin Woodland	2241	Piquant	2244	Wild Mink Shimmer 2249
Jet Black	2248	Pristine	2245	
Metallic Mauve	2242	Stonemired	2246	

<b>Champagne Toast 1 1/4" Single Cell</b>				
Baroque	4240	Nutmeg Gleam	4243	Thicket Gloss 4247
Elfin Woodland	4241	Piquant	4244	Wild Mink Shimmer 4249
Jet Black	4248	Pristine	4245	
Metallic Mauve	4242	Stonemired	4246	

<b>Valletta Blackout 3/4" Single Cell*</b>				
Coconut Cream	1020	Indigo Intrigue	1027	Stallion 1031
Crisp Carbon	1026	Manila	1021	Trevi 1024
Gourmet Chocolate	1029	Plebian Blue	1028	
Gray Moss	1030	Simply White	1022	

\*Color coordinated with Valletta (light filtering)

<b>Valletta Blackout 1 1/4" Single Cell*</b>				
Coconut Cream	3020	Simply White	3022	Trevi 3024
Manila	3021	Stallion	3031	

\*Color coordinated with Valletta (light filtering)

## Options Pricing

### Perfect Arches: Half Circle

Width up to inches (cm) →

	24 (61)	30 (76.2)	36 (91.5)	42 (106.7)	48 (122)	54 (137.2)	60 (152.4)	66 (167.7)	72 (182.9)	84 (213.4)
Price Group A	218	239	272	300	344	394	443	498	550	605
Price Group B	230	252	290	320	366	419	470	529	581	642
Price Group C	287	313	359	394	453	519	582	656	721	796
Price Group D	314	343	393	431	497	570	639	716	790	874
Price Group E	321	350	401	440	508	581	651	731	807	891
Price Group F	366	398	458	502	581	665	744	837	923	1019
Price Group G	387	422	482	530	613	701	786	880	974	1075
Price Group H	450	489	559	616	710	812	912	1022	1128	1247
Price Group I	591	643	737	809	935	1066	1197	1343	1483	1640
Price Group J	691	752	861	947	1094	1248	1401	1571	1735	1918

### Non-Perfect Arches

Width up to inches (cm) →

	24 (61)	30 (76.2)	36 (91.5)	42 (106.7)	48 (122)	54 (137.2)	60 (152.4)	66 (167.7)	72 (182.9)	84 (213.4)
Price Group A	280	311	353	392	451	515	575	651	714	785
Price Group B	299	331	372	418	478	545	609	691	755	831
Price Group C	371	411	464	517	592	678	758	857	937	1031
Price Group D	404	450	508	565	649	743	828	938	1027	1130
Price Group E	413	459	519	579	662	758	848	956	1048	1151
Price Group F	472	524	592	661	758	867	968	1096	1199	1318
Price Group G	498	554	624	697	797	914	1021	1154	1265	1391
Price Group H	580	642	725	808	923	1062	1185	1338	1466	1614
Price Group I	761	843	952	1062	1215	1394	1558	1760	1928	2121
Price Group J	890	985	1113	1243	1422	1631	1822	2060	2256	2482

### Option

Bottom Up/Top Down Cordless Lift	104 No additional charge for cordless lift
Bottom Up/Top Down Motorized Lift	See motorization product information guide
Continuous-Loop Lift (recommended for large, heavy shades)	104
Cordless Lift	No charge
Fabric Wrapped Rails	111 Champagne Toast with Cordless, Motorized or Continuous Loop Lift 94 Splendor or Sanctuary with Cordless, Motorized or Continuous Loop Lift 146 Champagne Toast with Bottom up / Top Down or Sun up / Sun Down 122 Splendor or Sanctuary with Bottom up / Top Down or Sun up / Sun Down
Lightblocking Strip	No charge
Motorized Lift	See motorization product information guide
Multiple Shades on One Headrail	If less than or equal to 144" (365.8 cm), surcharge applies: 104 Two-on-one headrail 104 Three-on-one headrail
Perfect-View Shade—Cordless Lift	See price chart and add one cordless lift surcharge
Reversible Fabrics	No charge
Room Darkening Side Channels	Price side channels and sill channels separately and combine Side Channel: 34 per foot (Comes in a set of 2. Order to finished shade height.) Sill Channel: 16 per foot (Order to finished shade width)
Sky Pole	49 3 to 6 1/2 feet (91.5 cm to 198.2 cm) 74 5 to 9 1/2 feet (152.4 cm to 289.6 cm)
Skytrack Skylight	130
Sun Up/Sun Down—Cordless Lift	Price as two separate cord lift shades and combine both prices for total shade cost; no charge for cordless lift
Template Service	27 net
Top Down Only	88 plus the continuous-loop lift surcharge
Wood Cornices and Valances	See wood cornices and valances product information guide
Specialty Shapes	
Angled Top/Angled Bottom Octagon, Hexagon, or Trapezoid	173 add to price as base shade using angled width and longest height 264 add to price as base shade using widest width and largest height
Perfect Arches and Non-Perfect Arches	See arch pricing