



 **KIRSCH**<sup>®</sup>  
DRAPERY HARDWARE

Wrought Iron

2024 Price Guide



SPARKED BY TRADITION

---

# WROUGHT IRON: FOR LOVERS OF OLD WORLD TRADITION

**Real Wrought Iron** is sand casted  
by skilled iron workers.

**Time-honored** methods and designs.

**Hand finished** so all unique textures  
and qualities are showcased.

---

Our skilled iron workers still use the time-honored methods to form classic, heavyweight wrought iron products, while protecting the authenticity of the craft and keeping the timeless practice of this beautiful tradition alive. We are proud to keep this remarkable custom alive with the Kirsch Wrought Iron Collection.

---



# CONTENTS

|    |  |
|----|--|
| 06 | Overview                                 |
| 08 | 1" Finials & Components                  |
| 18 | 1 3/8" Finials & Components              |
| 28 | Helpful Guides                           |
| 28 | AMP™ Motorization                        |
| 30 | Estate™ Overview                         |
| 32 | Bracket Spacing<br>& Mount Option        |
| 34 | Calculating Drapery Weight               |
| 35 | Stack Guides                             |
| 42 | Pole Installation,<br>Cutting & Splicing |
| 43 | Complete Collection Overview             |
| 45 | Index                                    |



# COLLECTION OVERVIEW

6

## FINISHES

An alluring range of metals

2

## VERSATILE SIZES

1" & 1 $\frac{3}{8}$ "

1

## ESTATE™ TRAVERSE ROD SIZES

1 $\frac{3}{8}$ "

1

## REMARKABLE COLLECTION

### ARCHITRAC™ K-RAIL COMPATIBLE

1 $\frac{3}{8}$ " finials only

### AMP™ MOTORIZATION COMPATIBLE

Estate™ Traverse Rods only





2

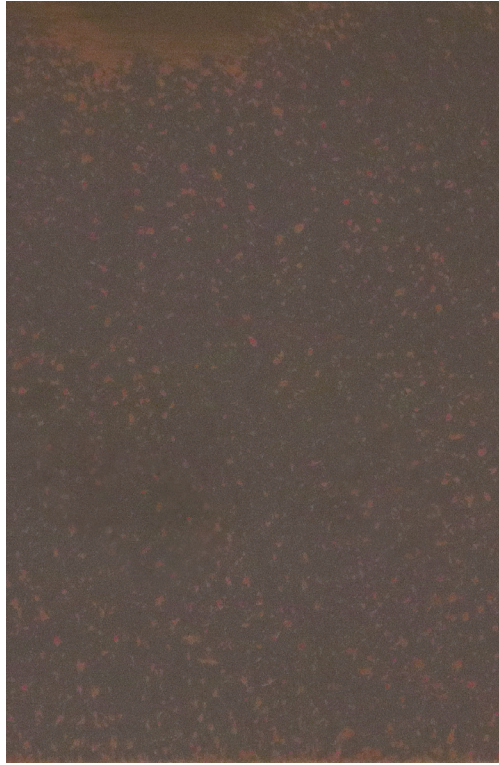

3

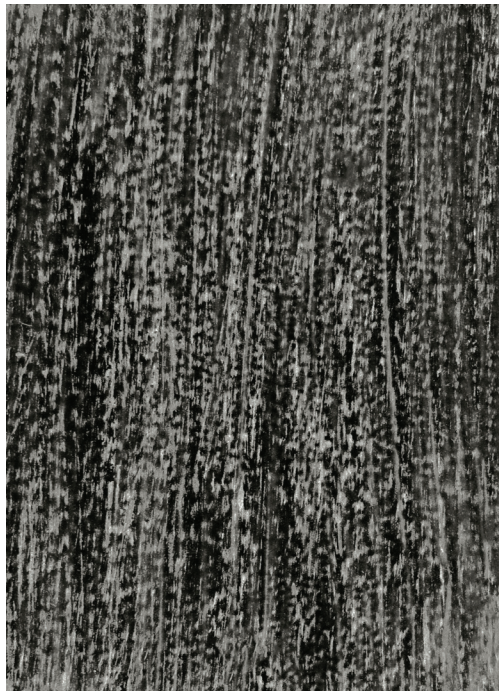

4

- 1 | Black
- 2 | Iron Oxide
- 3 | Rust
- 4 | Graphite | **NEW**
- 5 | Chalk | **NEW**
- 6 | Heirloom Copper | **NEW**

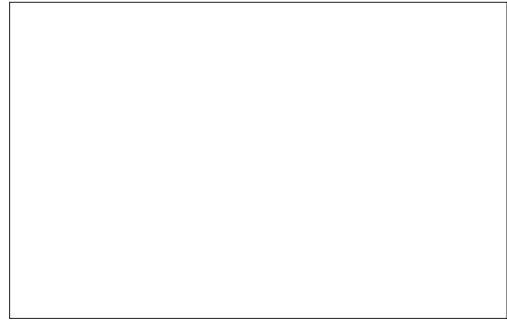

5



6

# 1" Finials & Endcaps

## Axiom

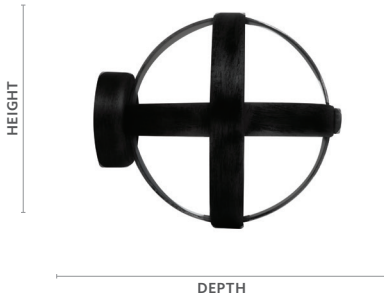

| Fits                  | Dimensions                              | Quantity per Box | Full Pack | Broken Pack |
|-----------------------|---|------------------|-----------|-------------|
| 1" Wrought Iron Poles | Depth: 3¼"<br>Height: 2⅞"<br>Width: 2⅞" | 5 pairs per box  | \$40.04   | \$55.61     |

| Product Number & Finish |       |          |                 |                     |
|-------------------------|-------|----------|-----------------|---------------------|
| 56381770                | Black | 56381804 | Graphite        | 56381802 Iron Oxide |
| 56381803                | Chalk | 56381805 | Heirloom Copper | 56381777 Rust       |

Finial Plugs included.

## Darby



| Fits                  | Dimensions                              | Quantity per Box | Full Pack | Broken Pack |
|-----------------------|---|------------------|-----------|-------------|
| 1" Wrought Iron Poles | Depth: 2⅞"<br>Height: 1½"<br>Width: 1½" | 5 pairs per box  | \$40.04   | \$55.61     |

| Product Number & Finish |       |          |                 |                     |
|-------------------------|-------|----------|-----------------|---------------------|
| 56384770                | Black | 56384804 | Graphite        | 56384802 Iron Oxide |
| 56384803                | Chalk | 56384805 | Heirloom Copper | 56384777 Rust       |

Finial Plugs included.

## Lincoln



| Fits                  | Dimensions                              | Quantity per Box | Full Pack | Broken Pack |
|-----------------------|---|------------------|-----------|-------------|
| 1" Wrought Iron Poles | Depth: 2¼"<br>Height: 1⅜"<br>Width: 1⅜" | 5 pairs per box  | \$40.04   | \$55.61     |

| Product Number & Finish |       |          |                 |                     |
|-------------------------|-------|----------|-----------------|---------------------|
| 56383770                | Black | 56383804 | Graphite        | 56383802 Iron Oxide |
| 56383803                | Chalk | 56383805 | Heirloom Copper | 56383777 Rust       |

Finial Plugs included.

## Otto



| Fits                  | Dimensions                              | Quantity per Box | Full Pack | Broken Pack |
|-----------------------|---|------------------|-----------|-------------|
| 1" Wrought Iron Poles | Depth: 2⅞"<br>Height: 2⅞"<br>Width: 2⅞" | 5 pairs per box  | \$40.04   | \$55.61     |

| Product Number & Finish |       |          |                 |                     |
|-------------------------|-------|----------|-----------------|---------------------|
| 56382770                | Black | 56382804 | Graphite        | 56382802 Iron Oxide |
| 56382803                | Chalk | 56382805 | Heirloom Copper | 56382777 Rust       |

Finial Plugs included.





Otto | Black  
Lincoln | Chalk  
Darby | Heirloom Copper

# 1" Finials & Endcaps

## Pedestal Ball



| Fits                  | Dimensions                            | Quantity per Box | Full Pack | Broken Pack |
|-----------------------|---------------------------------------|------------------|-----------|-------------|
| 1" Wrought Iron Poles | Depth: 3¼"<br>Height: 2"<br>Width: 2" | 5 pairs per box  | \$40.04   | \$55.61     |

| Product Number & Finish |       |          |                 |          |            |
|-------------------------|-------|----------|-----------------|----------|------------|
| 56351770                | Black | 56351804 | Graphite        | 56351802 | Iron Oxide |
| 56351803                | Chalk | 56351805 | Heirloom Copper | 56351777 | Rust       |

Finial Plugs included.

## Petite Faucet



| Fits                  | Dimensions                              | Quantity per Box | Full Pack | Broken Pack |
|-----------------------|---|------------------|-----------|-------------|
| 1" Wrought Iron Poles | Depth: 1¾"<br>Height: 1¾"<br>Width: 1¾" | 5 pairs per box  | \$26.01   | \$36.12     |

| Product Number & Finish |       |          |                 |          |            |
|-------------------------|-------|----------|-----------------|----------|------------|
| 56374770                | Black | 56374804 | Graphite        | 56374802 | Iron Oxide |
| 56374803                | Chalk | 56374805 | Heirloom Copper | 56374777 | Rust       |

Finial Plugs included.



1¾" Otto | Black  
1" Otto | Rust

# 1" Finials & Endcaps

## Petite Modern Ball



| Fits                  | Dimensions                             | Quantity per Box | Full Pack | Broken Pack |
|-----------------------|--|------------------|-----------|-------------|
| 1" Wrought Iron Poles | Depth: 2"<br>Height: 1¾"<br>Width: 1¾" | 5 pairs per box  | \$26.01   | \$36.12     |

| Product Number & Finish |       |                 |                 |                            |
|-------------------------|-------|-----------------|-----------------|----------------------------|
| <b>56373770</b>         | Black | <b>56373804</b> | Graphite        | <b>56373802</b> Iron Oxide |
| <b>56373803</b>         | Chalk | <b>56373805</b> | Heirloom Copper | <b>56373777</b> Rust       |

Finial Plugs included.

## Ponce



| Fits                  | Dimensions  | Quantity per Box | Full Pack | Broken Pack |
|-----------------------|---|------------------|-----------|-------------|
| 1" Wrought Iron Poles | Depth: 4 <sup>13</sup> / <sub>16</sub> "<br>Height: 1½"<br>Width: 1½" | 5 pairs per box  | \$40.04   | \$55.61     |

| Product Number & Finish |       |                 |                 |                            |
|-------------------------|-------|-----------------|-----------------|----------------------------|
| <b>56385770</b>         | Black | <b>56385804</b> | Graphite        | <b>56385802</b> Iron Oxide |
| <b>56385803</b>         | Chalk | <b>56385805</b> | Heirloom Copper | <b>56385777</b> Rust       |

Finial Plugs included.

## Endcap



| Fits                  | Dimensions                             | Quantity per Box | Full Pack | Broken Pack |
|-----------------------|--|------------------|-----------|-------------|
| 1" Wrought Iron Poles | Depth: ¾"<br>Height: 1½"<br>Width: 1½" | 5 pairs per box  | \$15.39   | \$21.37     |

| Product Number & Finish |       |                 |                 |                            |
|-------------------------|-------|-----------------|-----------------|----------------------------|
| <b>56358770</b>         | Black | <b>56358804</b> | Graphite        | <b>56358802</b> Iron Oxide |
| <b>56358803</b>         | Chalk | <b>56358805</b> | Heirloom Copper | <b>56358777</b> Rust       |

Finial Plugs included.

# 1" Poles

## 6' Pole



| Diameter | Length | Quantity per Box | Full Pack | Broken Pack |
|----------|--------|------------------|-----------|-------------|
| 1"       | 6'     | 6 pieces per box | \$41.39   | \$57.78     |

### Product Number & Finish

|          |       |          |                 |          |            |
|----------|-------|----------|-----------------|----------|------------|
| 56359770 | Black | 56359804 | Graphite        | 56359802 | Iron Oxide |
| 56359803 | Chalk | 56359805 | Heirloom Copper | 56359777 | Rust       |

## 8' Pole



| Diameter | Length | Quantity per Box | Full Pack | Broken Pack |
|----------|--------|------------------|-----------|-------------|
| 1"       | 8'     | 6 pieces per box | \$54.68   | \$75.95     |

### Product Number & Finish

|          |       |          |                 |          |            |
|----------|-------|----------|-----------------|----------|------------|
| 56360770 | Black | 56360804 | Graphite        | 56360802 | Iron Oxide |
| 56360803 | Chalk | 56360805 | Heirloom Copper | 56360777 | Rust       |

# 1" Rings

## Ring



| Fits                  | Dimensions  | Quantity per Box                     | Full Pack | Broken Pack |
|-----------------------|---|--------------------------------------|-----------|-------------|
| 1" Wrought Iron Poles | Internal: 1½"<br>External: 2½"<br>External to eyelet: 2¾" | 10 bags per box -<br>7 rings per bag | \$20.05   | \$27.85     |

| Product Number & Finish |       |          |                 |          |            |
|-------------------------|-------|----------|-----------------|----------|------------|
| 56361770                | Black | 56361804 | Graphite        | 56361802 | Iron Oxide |
| 56361803                | Chalk | 56361805 | Heirloom Copper | 56361777 | Rust       |

## Bypass C-Ring



| Fits                  | Dimensions  | Quantity per Box                     | Full Pack | Broken Pack |
|-----------------------|---|--------------------------------------|-----------|-------------|
| 1" Wrought Iron Poles | Internal: 1½"<br>External: 2½"<br>External to eyelet: 2¾" | 10 bags per box -<br>7 rings per bag | \$21.32   | \$29.61     |

| Product Number & Finish |       |          |                 |          |            |
|-------------------------|-------|----------|-----------------|----------|------------|
| 56371770                | Black | 56371804 | Graphite        | 56371802 | Iron Oxide |
| 56371803                | Chalk | 56371805 | Heirloom Copper | 56371777 | Rust       |

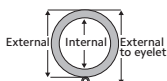

Use the measurement guide to the left to help determine the correct dimensions for your selected product.

# 1" Brackets

## 3½" Return Bracket



| Fits                    | Dimensions   | Quantity per Box | Full Pack       | Broken Pack         |
|-------------------------|--|------------------|-----------------|---------------------|
| 1" Wrought Iron Poles   | Depth: 4¼"<br>Height: 4"<br>Width: ⅝"<br>Wall to Pole: 3"<br>Return: 3½" | 5 pieces per box | \$12.05         | \$16.74             |
| Product Number & Finish |  |                  |                 |                     |
| 56362770                | Black  | 56362804         | Graphite        | 56362802 Iron Oxide |
| 56362803                | Chalk  | 56362805         | Heirloom Copper | 56362777 Rust       |

## 5⅜" Return Bracket



| Fits                    | Dimensions   | Quantity per Box | Full Pack       | Broken Pack         |
|-------------------------|--|------------------|-----------------|---------------------|
| 1" Wrought Iron Poles   | Depth: 6¼"<br>Height: 4¼"<br>Width: ⅝"<br>Wall to Pole: 4⅞"<br>Return: 5⅜" | 5 pieces per box | \$14.68         | \$20.38             |
| Product Number & Finish |  |                  |                 |                     |
| 56363770                | Black  | 56363804         | Graphite        | 56363802 Iron Oxide |
| 56363803                | Chalk  | 56363805         | Heirloom Copper | 56363777 Rust       |

## Center Bypass Bracket



| Fits                    | Dimensions   | Quantity per Box | Full Pack       | Broken Pack         |
|-------------------------|--|------------------|-----------------|---------------------|
| 1" Wrought Iron Poles   | Depth: 4¼"<br>Height: 4"<br>Width: ⅝"<br>Wall to Pole: 3"<br>Return: 3½" | 5 pieces per box | \$12.05         | \$16.74             |
| Product Number & Finish |  |                  |                 |                     |
| 56372770                | Black  | 56372804         | Graphite        | 56372802 Iron Oxide |
| 56372803                | Chalk  | 56372805         | Heirloom Copper | 56372777 Rust       |

## Double Bracket



| Fits                    | Dimensions   | Quantity per Box | Full Pack       | Broken Pack         |
|-------------------------|--|------------------|-----------------|---------------------|
| 1" Wrought Iron Poles   | Depth: 7½"<br>Height: 5⅝"<br>Width: ⅝"<br>Wall to Pole: 3"<br>Inner Return: 3½"<br>Outer Return: 6½" | 5 pieces per box | \$18.72         | \$26.00             |
| Product Number & Finish |  |                  |                 |                     |
| 56365770                | Black  | 56365804         | Graphite        | 56365802 Iron Oxide |
| 56365803                | Chalk  | 56365805         | Heirloom Copper | 56365777 Rust       |

# 1" Brackets, Accessories & Components

## Inside Mount Socket



| Fits                  | Dimensions                           | Quantity per Box | Full Pack | Broken Pack |
|-----------------------|--------------------------------------|------------------|-----------|-------------|
| 1" Wrought Iron Poles | Depth: 1"<br>Height: 2"<br>Width: 2" | 5 pairs per box  | \$17.37   | \$24.12     |

### Product Number & Finish

|                 |       |                 |                 |                 |            |
|-----------------|-------|-----------------|-----------------|-----------------|------------|
| <b>56370770</b> | Black | <b>56370804</b> | Graphite        | <b>56370802</b> | Iron Oxide |
| <b>56370803</b> | Chalk | <b>56370805</b> | Heirloom Copper | <b>56370805</b> | Rust       |

Mounts a 1" rod between two facing walls.

## Swivel Socket



| Fits                  | Dimensions   | Quantity per Box | Full Pack | Broken Pack |
|-----------------------|--|------------------|-----------|-------------|
| 1" Wrought Iron Poles | Partial Length: 1½"<br>Plug Length: ¾"<br>Full Length: 2½" | 5 pieces per box | \$17.37   | \$24.12     |

### Product Number & Finish

|                 |       |                 |                 |                 |            |
|-----------------|-------|-----------------|-----------------|-----------------|------------|
| <b>56367770</b> | Black | <b>56367804</b> | Graphite        | <b>56367802</b> | Iron Oxide |
| <b>56367803</b> | Chalk | <b>56367805</b> | Heirloom Copper | <b>56367777</b> | Rust       |

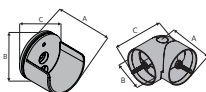

Use the measurement guide to the left to help determine the correct dimensions for your selected product.

# 1" Accessories & Components

## 36" Baton with Bypass C-Ring



| Fits                    | Dimensions | Quantity per Box | Full Pack       | Broken Pack |            |
|-------------------------|------------|------------------|-----------------|-------------|------------|
| 1" Wrought Iron Poles   | 36" long   | 6 pieces per box | \$21.32         | \$29.61     |            |
| Product Number & Finish |            |                  |                 |             |            |
| 56375770                | Black      | 56375804         | Graphite        | 56375802    | Iron Oxide |
| 56375803                | Chalk      | 56375805         | Heirloom Copper | 56375777    | Rust       |

## Finial Plug



| Fits                    | Quantity per Box  | Full Pack | Broken Pack |
|-------------------------|-------------------|-----------|-------------|
| 1" Wrought Iron Poles   | 50 pieces per box | \$0.34    | \$0.47      |
| Product Number & Finish |                   |           |             |
| 56369058                | White             |           |             |

## Internal Rod Splice



| Fits                    | Quantity per Box | Full Pack | Broken Pack |
|-------------------------|------------------|-----------|-------------|
| 1" Wrought Iron Poles   | 5 pieces per box | \$7.39    | \$10.26     |
| Product Number & Finish |                  |           |             |
| 56366061                | Zinc Plated      |           |             |

Connects two poles together for larger width options.





Petite Modern Ball | Black

# 1 3/8" Finials & Endcaps

## Axiom

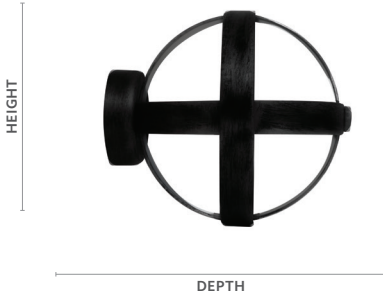

| Fits                         | Dimensions      | Quantity per Box | Full Pack | Broken Pack |
|------------------------------|-----------------|------------------|-----------|-------------|
| 1 3/8" Wrought Iron Poles    | Depth: 3 13/16" | 5 pairs per box  | \$68.19   | \$94.72     |
| 1 3/8" Estate™ Traverse Rods | Height: 3 3/8"  |                  |           |             |
| 1 3/8" K-Rail Traverse Rods  | Width: 3 3/8"   |                  |           |             |

| Product Number & Finish |       |          |                 |          |            |
|-------------------------|-------|----------|-----------------|----------|------------|
| 56481770                | Black | 56481804 | Graphite        | 56481802 | Iron Oxide |
| 56481803                | Chalk | 56481805 | Heirloom Copper | 56481777 | Rust       |

Finial Plugs included.

## Darby



| Fits                         | Dimensions    | Quantity per Box | Full Pack | Broken Pack |
|------------------------------|---------------|------------------|-----------|-------------|
| 1 3/8" Wrought Iron Poles    | Depth: 3 1/4" | 5 pairs per box  | \$68.19   | \$94.72     |
| 1 3/8" Estate™ Traverse Rods | Height: 2"    |                  |           |             |
| 1 3/8" K-Rail Traverse Rods  | Width: 2"     |                  |           |             |

| Product Number & Finish |       |          |                 |          |            |
|-------------------------|-------|----------|-----------------|----------|------------|
| 56484770                | Black | 56484804 | Graphite        | 56484802 | Iron Oxide |
| 56484803                | Chalk | 56484805 | Heirloom Copper | 56484777 | Rust       |

Finial Plugs included.



Axiom | Graphite

# 1 3/8" Finials & Endcaps

## Lincoln

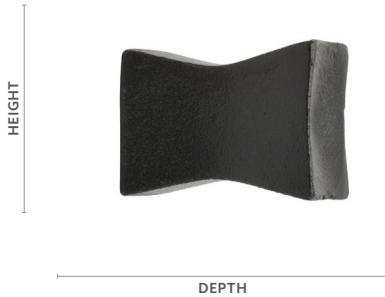

| Fits   | Dimensions                                       | Quantity per Box | Full Pack | Broken Pack |
|--|--|------------------|-----------|-------------|
| 1 3/8" Wrought Iron Poles<br>1 3/8" Estate™ Traverse Rods<br>1 3/8" K-Rail Traverse Rods | Depth: 2 5/8"<br>Height: 2 1/8"<br>Width: 2 1/8" | 5 pairs per box  | \$68.19   | \$94.72     |

| Product Number & Finish |       |                 |                 |                            |
|-------------------------|-------|-----------------|-----------------|----------------------------|
| <b>56483770</b>         | Black | <b>56483804</b> | Graphite        | <b>56483802</b> Iron Oxide |
| <b>56483803</b>         | Chalk | <b>56483805</b> | Heirloom Copper | <b>56483777</b> Rust       |

Finial Plugs included.

## Otto



| Fits   | Dimensions  | Quantity per Box | Full Pack | Broken Pack |
|--|---|------------------|-----------|-------------|
| 1 3/8" Wrought Iron Poles<br>1 3/8" Estate™ Traverse Rods<br>1 3/8" K-Rail Traverse Rods | Depth: 2 5/16"<br>Height: 3 1/4"<br>Width: 3 1/4" | 5 pairs per box  | \$68.19   | \$94.72     |

| Product Number & Finish |       |                 |                 |                            |
|-------------------------|-------|-----------------|-----------------|----------------------------|
| <b>56482770</b>         | Black | <b>56482804</b> | Graphite        | <b>56482802</b> Iron Oxide |
| <b>56482803</b>         | Chalk | <b>56482805</b> | Heirloom Copper | <b>56482777</b> Rust       |

Finial Plugs included.

## Pedestal Ball



| Fits   | Dimensions                                       | Quantity per Box | Full Pack | Broken Pack |
|--|--|------------------|-----------|-------------|
| 1 3/8" Wrought Iron Poles<br>1 3/8" Estate™ Traverse Rods<br>1 3/8" K-Rail Traverse Rods | Depth: 4 7/8"<br>Height: 3 3/8"<br>Width: 3 3/8" | 5 pairs per box  | \$68.19   | \$94.72     |

| Product Number & Finish |       |                 |                 |                            |
|-------------------------|-------|-----------------|-----------------|----------------------------|
| <b>56451770</b>         | Black | <b>56451804</b> | Graphite        | <b>56451802</b> Iron Oxide |
| <b>56451803</b>         | Chalk | <b>56451805</b> | Heirloom Copper | <b>56451777</b> Rust       |

Finial Plugs included.

## Petite Faucet



| Fits   | Dimensions   | Quantity per Box | Full Pack | Broken Pack |
|--|--|------------------|-----------|-------------|
| 1 3/8" Wrought Iron Poles<br>1 3/8" Estate™ Traverse Rods<br>1 3/8" K-Rail Traverse Rods | Depth: 2 3/8"<br>Height: 2 3/16"<br>Width: 2 3/16" | 5 pairs per box  | \$45.05   | \$62.58     |

| Product Number & Finish |       |                 |                 |                            |
|-------------------------|-------|-----------------|-----------------|----------------------------|
| <b>56474770</b>         | Black | <b>56474804</b> | Graphite        | <b>56474802</b> Iron Oxide |
| <b>56474803</b>         | Chalk | <b>56474805</b> | Heirloom Copper | <b>56474777</b> Rust       |

Finial Plugs included.

# 1 3/8" Finials & Endcaps

## Petite Modern Ball



| Fits                         | Dimensions       | Quantity per Box | Full Pack | Broken Pack |
|------------------------------|------------------|------------------|-----------|-------------|
| 1 3/8" Wrought Iron Poles    | Depth: 3 3/8"    | 5 pairs per box  | \$45.05   | \$62.58     |
| 1 3/8" Estate™ Traverse Rods | Height: 1 15/16" |                  |           |             |
| 1 3/8" K-Rail Traverse Rods  | Width: 1 15/16"  |                  |           |             |

| Product Number & Finish |       |                 |                 |                            |
|-------------------------|-------|-----------------|-----------------|----------------------------|
| <b>56473770</b>         | Black | <b>56473804</b> | Graphite        | <b>56473802</b> Iron Oxide |
| <b>56473803</b>         | Chalk | <b>56473805</b> | Heirloom Copper | <b>56473777</b> Rust       |

Finial Plugs included.

## Ponce



| Fits                         | Dimensions     | Quantity per Box | Full Pack | Broken Pack |
|------------------------------|----------------|------------------|-----------|-------------|
| 1 3/8" Wrought Iron Poles    | Depth: 5 1/2"  | 5 pairs per box  | \$68.19   | \$94.72     |
| 1 3/8" Estate™ Traverse Rods | Height: 1 1/4" |                  |           |             |
| 1 3/8" K-Rail Traverse Rods  | Width: 1 1/4"  |                  |           |             |

| Product Number & Finish |       |                 |                 |                            |
|-------------------------|-------|-----------------|-----------------|----------------------------|
| <b>56485770</b>         | Black | <b>56485804</b> | Graphite        | <b>56485802</b> Iron Oxide |
| <b>56485803</b>         | Chalk | <b>56485805</b> | Heirloom Copper | <b>56485777</b> Rust       |

Finial Plugs included.

## Endcap



| Fits                         | Dimensions     | Quantity per Box | Full Pack | Broken Pack |
|------------------------------|----------------|------------------|-----------|-------------|
| 1 3/8" Wrought Iron Poles    | Depth: 1 1/8"  | 5 pairs per box  | \$27.68   | \$38.44     |
| 1 3/8" Estate™ Traverse Rods | Height: 2 1/2" |                  |           |             |
| 1 3/8" K-Rail Traverse Rods  | Width: 2 1/2"  |                  |           |             |

| Product Number & Finish |       |                 |                 |                            |
|-------------------------|-------|-----------------|-----------------|----------------------------|
| <b>56458770</b>         | Black | <b>56458804</b> | Graphite        | <b>56458802</b> Iron Oxide |
| <b>56458803</b>         | Chalk | <b>56458805</b> | Heirloom Copper | <b>56458777</b> Rust       |

Finial Plugs included.

# 1 3/8" Poles

## 6' Pole



| Diameter | Length | Quantity per Box | Full Pack | Broken Pack |
|----------|--------|------------------|-----------|-------------|
| 1 3/8"   | 6'     | 6 pieces per box | \$43.79   | \$60.81     |

### Product Number & Finish

|          |       |          |                 |          |            |
|----------|-------|----------|-----------------|----------|------------|
| 56459770 | Black | 56459804 | Graphite        | 56459802 | Iron Oxide |
| 56459803 | Chalk | 56459805 | Heirloom Copper | 56459777 | Rust       |

## 8' Pole



| Diameter | Length | Quantity per Box | Full Pack | Broken Pack |
|----------|--------|------------------|-----------|-------------|
| 1 3/8"   | 8'     | 6 pieces per box | \$56.60   | \$78.61     |

### Product Number & Finish

|          |       |          |                 |          |            |
|----------|-------|----------|-----------------|----------|------------|
| 56460770 | Black | 56460804 | Graphite        | 56460802 | Iron Oxide |
| 56460803 | Chalk | 56460805 | Heirloom Copper | 56460777 | Rust       |



# 1 3/8" Estate™ Traverse Rod

To learn more about the technical specs on Estate Traverse Rods and AMP™ Motorization, see pages 28-31.

## Assembled Set with Slides



| Manual Traversing Rods with Selected Carriers              |       |          |                 |          |            |
|--|-------|----------|-----------------|----------|------------|
| Unit of Measure  |       |          | Dealer Cost     |          |            |
| Foot   |       |          | \$49.00         |          |            |
| AMP™ Motorization Upcharge                                 |       |          |                 |          |            |
| Charger, item #62201300 included. Remotes sold separately. |       |          |                 |          |            |
| add \$580.00   |       |          |                 |          |            |
| Product Number & Finish                                    |       |          |                 |          |            |
| 83697770   | Black | 83697804 | Graphite        | 83697802 | Iron Oxide |
| 83697803   | Chalk | 83697805 | Heirloom Copper | 83697777 | Rust       |

## Assembled Set with Wheeled Ripplefold™ Carriers



| Manual Traversing Rods with Selected Carriers              |       |          |                 |          |            |
|--|-------|----------|-----------------|----------|------------|
| Unit of Measure  |       |          | Dealer Cost     |          |            |
| Foot   |       |          | \$49.00         |          |            |
| AMP™ Motorization Upcharge                                 |       |          |                 |          |            |
| Charger, item #62201300 included. Remotes sold separately. |       |          |                 |          |            |
| add \$580.00   |       |          |                 |          |            |
| Product Number & Finish                                    |       |          |                 |          |            |
| 83698770   | Black | 83698804 | Graphite        | 83698802 | Iron Oxide |
| 83698803   | Chalk | 83698805 | Heirloom Copper | 83698777 | Rust       |

## 1 3/8" Estate™ Keystone

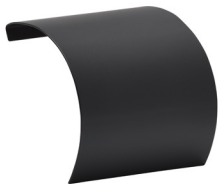

| Fits                         | Quantity per Box  | Full Pack | Broken Pack     |         |            |
|------------------------------|-------------------|-----------|-----------------|---------|------------|
| 1 3/8" Estate™ Traverse Rods | 25 pieces per box | \$9.54    | \$13.25         |         |            |
| Product Number & Finish      |                   |           |                 |         |            |
| 1833770                      | Black             | 1833804   | Graphite        | 1833802 | Iron Oxide |
| 1833803                      | Chalk             | 1833805   | Heirloom Copper | 1833777 | Rust       |

# 1 3/8" Estate™ Traverse Rod Components

To learn more about the technical specs on Estate Traverse Rods and AMP™ Motorization, see pages 28-31.

## Double Bracket

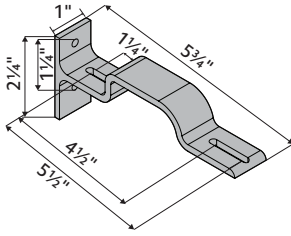

| Fits   | Dimensions                                   | Quantity per Box  | Full Pack | Broken Pack |
|--|--|-------------------|-----------|-------------|
| 1 3/8" Estate™ Traverse Rods<br>2" Estate™ Traverse Rods | Depth: 5 3/4"<br>Height: 2 1/4"<br>Width: 1" | 10 pieces per box | \$11.63   | \$16.15     |
| Product Number & Finish                                  |  |                   |           |             |
| 71134110 Satin Brass                                     |  |                   |           |             |

## Double Bracket

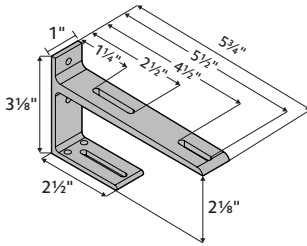

| Fits   | Dimensions                                   | Quantity per Box  | Full Pack | Broken Pack |
|--|--|-------------------|-----------|-------------|
| 1 3/8" Estate™ Traverse Rods<br>2" Estate™ Traverse Rods | Depth: 5 3/4"<br>Height: 3 1/8"<br>Width: 1" | 10 pieces per box | \$11.63   | \$16.15     |
| Product Number & Finish                                  |  |                   |           |             |
| 71132062 Antique Brass                                   | 71132110 Satin Brass                         |                   |           |             |
| 71132006 Black   | 71132012 Satin Nickel                        |                   |           |             |

| Item | Product No. & Finish             | Description                                    | Quantity Per Box  | Full Pack Price | Broken Pack Price |
|------|----------------------------------|--|-------------------|-----------------|-------------------|
|      | 62101000 White<br>62101010 Black | AMP Remote Control RF 2W<br>15 Channel         | 1 piece per box   | \$44.67         | n/a               |
|      | 62201300 White                   | AMP Battery Charger 16.5V/0.89A                | 1 piece per box   | \$18.86         | n/a               |
|      | 62102000 White                   | AMP Gateway USB Bridge                         | 1 piece per box   | \$131.93        | n/a               |
|      | 62109000 White                   | AMP Wall Switch Surface<br>RF 2W<br>15 Channel | 1 piece per box   | \$57.64         | n/a               |
|      | 62108000 White                   | AMP Wall Switch RF 2W<br>15 Channel            | 1 piece per box   | \$36.03         | n/a               |
|      | 1026660                          | 15" Cable Assembly                             | 10 pieces per box | \$5.80          | n/a               |
|      | 1026661                          | 4' Cable Assembly                              | 10 pieces per box | \$6.91          | n/a               |
|      | 1026662                          | 10' Cable Assembly                             | 10 pieces per box | \$10.28         | n/a               |
|      | 1026663                          | 20' Cable Assembly                             | 10 pieces per box | \$14.87         | n/a               |

# 1 3/8" Rings

## Ring



| Fits                      | Dimensions   | Quantity per Box | Full Pack | Broken Pack |
|---------------------------|--|------------------|-----------|-------------|
| 1 3/8" Wrought Iron Poles | Internal: 2"<br>External: 2 1/2"<br>External to eyelet: 2 13/16" | 10 bags per box  | \$27.67   | \$38.44     |

| Product Number & Finish |       |          |                 |                     |
|-------------------------|-------|----------|-----------------|---------------------|
| 56461770                | Black | 56461804 | Graphite        | 56461802 Iron Oxide |
| 56461803                | Chalk | 56461805 | Heirloom Copper | 56461777 Rust       |

## Bypass C-Ring



| Fits                      | Dimensions   | Quantity per Box | Full Pack | Broken Pack |
|---------------------------|--|------------------|-----------|-------------|
| 1 3/8" Wrought Iron Poles | Internal: 2"<br>External: 2 1/2"<br>External to eyelet: 2 13/16" | 10 bags per box  | \$28.49   | \$39.57     |

| Product Number & Finish |       |          |                 |                     |
|-------------------------|-------|----------|-----------------|---------------------|
| 56471770                | Black | 56471804 | Graphite        | 56471802 Iron Oxide |
| 56471803                | Chalk | 56471805 | Heirloom Copper | 56471777 Rust       |

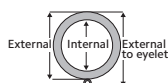

Use the measurement guide to the left to help determine the correct dimensions for your selected product.



# 1 3/8" Brackets

## 3 1/2" Return Bracket



| Fits                      | Dimensions  | Quantity per Box | Full Pack       | Broken Pack                |
|---------------------------|---|------------------|-----------------|----------------------------|
| 1 3/8" Wrought Iron Poles | Depth: 4 1/2"<br>Height: 4 1/8"<br>Width: 1 1/16"<br>Wall to Pole: 3"<br>Return: 3 1/2" | 5 pieces per box | \$23.21         | \$32.24                    |
| Product Number & Finish   |   |                  |                 |                            |
| <b>56462770</b>           | Black   | <b>56462804</b>  | Graphite        | <b>56462802</b> Iron Oxide |
| <b>56462803</b>           | Chalk   | <b>56462805</b>  | Heirloom Copper | <b>56462777</b> Rust       |

## 5 3/8" Return Bracket



| Fits                      | Dimensions   | Quantity per Box | Full Pack       | Broken Pack                |
|---------------------------|--|------------------|-----------------|----------------------------|
| 1 3/8" Wrought Iron Poles | Depth: 6 1/2"<br>Height: 4 5/16"<br>Width: 1 1/16"<br>Wall to Pole: 4 3/8"<br>Return: 5 3/8" | 5 pieces per box | \$31.20         | \$43.32                    |
| Product Number & Finish   |  |                  |                 |                            |
| <b>56463770</b>           | Black  | <b>56463804</b>  | Graphite        | <b>56463802</b> Iron Oxide |
| <b>56463803</b>           | Chalk  | <b>56463805</b>  | Heirloom Copper | <b>56463777</b> Rust       |

## Center Bypass Bracket



| Fits                      | Dimensions  | Quantity per Box | Full Pack       | Broken Pack                |
|---------------------------|---|------------------|-----------------|----------------------------|
| 1 3/8" Wrought Iron Poles | Depth: 4 3/8"<br>Height: 4 1/8"<br>Width: 1 1/16"<br>Wall to Pole: 3"<br>Return: 3 1/2" | 5 pieces per box | \$23.22         | \$32.24                    |
| Product Number & Finish   |   |                  |                 |                            |
| <b>56472770</b>           | Black   | <b>56472804</b>  | Graphite        | <b>56472802</b> Iron Oxide |
| <b>56472803</b>           | Chalk   | <b>56472805</b>  | Heirloom Copper | <b>56472777</b> Rust       |

## Double Bracket



| Fits                      | Dimensions  | Quantity per Box | Full Pack       | Broken Pack                |
|---------------------------|---|------------------|-----------------|----------------------------|
| 1 3/8" Wrought Iron Poles | Depth: 7 11/16"<br>Height: 5 3/8"<br>Width: 5/8"<br>Wall to Pole: 1 3/16"<br>Inner Return: 3 1/2"<br>Outer Return: 6 1/2" | 5 pieces per box | \$38.78         | \$53.86                    |
| Product Number & Finish   |   |                  |                 |                            |
| <b>56465770</b>           | Black   | <b>56465804</b>  | Graphite        | <b>56465802</b> Iron Oxide |
| <b>56465803</b>           | Chalk   | <b>56465805</b>  | Heirloom Copper | <b>56465777</b> Rust       |



Use the measurement guide to the left to help determine the correct dimensions for your selected product.

# 1 3/8" Bracket, Accessories & Components

## Inside Mount Socket



| Fits                      | Dimensions  | Quantity per Box | Full Pack | Broken Pack |
|---------------------------|---|------------------|-----------|-------------|
| 1 3/8" Wrought Iron Poles | Depth: 1 1/16"<br>Height: 2 3/8"<br>Width: 2 3/8" | 5 pairs per box  | \$18.56   | \$25.79     |

| Product Number & Finish |       |          |                 |                     |
|-------------------------|-------|----------|-----------------|---------------------|
| 56470770                | Black | 56470804 | Graphite        | 56470802 Iron Oxide |
| 56470803                | Chalk | 56470805 | Heirloom Copper | 56470777 Rust       |

Mounts a 1" rod between two facing walls.

## Swivel Socket



| Fits                      | Dimensions   | Quantity per Box | Full Pack | Broken Pack |
|---------------------------|--|------------------|-----------|-------------|
| 1 3/8" Wrought Iron Poles | Partial Length: 2 2/16"<br>Plug Length: 1 3/16"<br>Full Length: 3 1/2" | 5 pieces per box | \$20.73   | \$28.81     |

| Product Number & Finish |       |          |                 |                     |
|-------------------------|-------|----------|-----------------|---------------------|
| 56467770                | Black | 56467804 | Graphite        | 56467802 Iron Oxide |
| 56467803                | Chalk | 56467805 | Heirloom Copper | 56467777 Rust       |

## 36" Baton with Bypass C-Ring



| Fits                      | Dimensions | Quantity per Box | Full Pack | Broken Pack |
|---------------------------|------------|------------------|-----------|-------------|
| 1 3/8" Wrought Iron Poles | 36" long   | 6 pieces per box | \$23.77   | \$33.02     |

| Product Number & Finish |       |          |                 |                     |
|-------------------------|-------|----------|-----------------|---------------------|
| 56376770                | Black | 56376804 | Graphite        | 56376802 Iron Oxide |
| 56376803                | Chalk | 56376805 | Heirloom Copper | 56376777 Rust       |

## Finial Plug



| Fits                      | Quantity per Box  | Full Pack | Broken Pack |
|---------------------------|-------------------|-----------|-------------|
| 1 3/8" Wrought Iron Poles | 50 pieces per box | \$0.98    | \$1.36      |

| Product Number & Finish |       |
|-------------------------|-------|
| 56469058                | White |

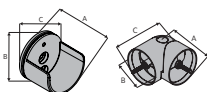

# 1" & 1 3/8" Accessories & Components

## Internal Rod Splice



| Fits                      | Quantity per Box | Full Pack | Broken Pack |
|---------------------------|------------------|-----------|-------------|
| 1 3/8" Wrought Iron Poles | 5 pieces per box | \$10.87   | \$15.09     |

### Product Number & Finish

**56466061** Zinc Plated

Connects two poles together for larger width options.

## Teflon Tape

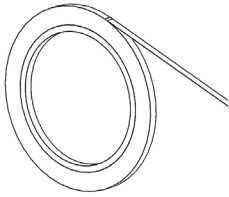

| Clearance    | Quantity per Box | Full Pack | Broken Pack |
|--------------|------------------|-----------|-------------|
| 54' per roll | 1 roll per box   | \$60.85   | n/a         |

### Product Number & Finish

**84990000** Clear

Teflon tape is used on stationary poles to help rings slide smoothly across the pole.

# AMP™ Motorization

## Why AMP™?

The slim design of the quiet, yet powerful motor and the position on the track allows the motor to tuck seamlessly behind your drapery panel so you'll never have to sacrifice your style or comfort. For safety measures, you're able to move the draperies with a gentle tug, allowing for operation when a remote is not present or if a guest is unaware of the motorization feature. The dual battery and AC power sources allows operation in case of a power outage so draperies may be opened in the event of an emergency. AMP™ Motorization is available on our most popular traversing tracks, Estate and Architrac® Series 94001 and in drapery header styles Ripplefold™ and pleated for a variety of styling options. This is comfortable living at its finest.

For AMP™ Motorization brochure, programming instructions and installation instructions, please visit the drapery hardware resource library at [kirsch.com](http://kirsch.com).

## Benefits & Features

### AMP™ Motorization

- Motor mounts to the back of the track which allows a seamless look between motorized and manual traverse rods
- Drapery fabrication does not need to change between manually controlled draperies and motorized draperies; No additional returns or any special instructions
- Limits are set automatically after installation
- Remote control is radio frequency and easily pairs with the motor
- Tug feature; when drapery is pulled the motor will traverse the drapery
- AMP™ App with AMP™ USB Bridge
- Architrac® Series 94001 Rods with AMP™ cannot be bent or curved

## Frequently Asked Questions

### What is the weight capacity?

**64 lbs** Motor is rated to 64 lbs. Be sure not to exceed the Estate or Architrac track specifications to ensure your motor operates optimally.

### Can you double the weight capacity by using two motors?

**No** Only use one motor per rod.

### Does AMP™ offer limit setting?

**Yes** The motor automatically sets its limits.

### Does AMP™ offer touch control?

**Yes** The tug feature allows you to pull on the drapery and the motor will automatically open or close your draperies.

### How long is the power cord?

**6 ft** The durable, non-extendable power cord is extra long for out of reach places. Any extra can be rolled and secured for a tidy look. Cable extensions are available in 15", 4', 10' and 20' lengths to reach outlets that are farther away from the motor.

### Is there a wall switch?

**Yes** There are Flush Mount and Surface Mount Wall Switches available.

### Does AMP™ offer a warranty?

**Yes** See the Kirsch Warranty document for more information.

Download the AMP™ APP to get started



# AMP™ Motorization Overview

## Overview

- Soft start/stop & manual operation
- Tug feature: when drapery is pulled the motor will traverse the drapery
- Automatic limits on end stop
- Favorite/intermediate position
- Dry contact for external control
- RF Remote and wall switches
- Setting with buttons on motor units
- Setting with external dry contact switch
- LED Indicators
- One-Way and Two-Way Draw
- Pleated
- Ripplefold™
- AMP™ App with AMP™ USB Bridge

## Available Colors

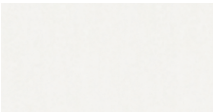

White

## Side View



## Front View

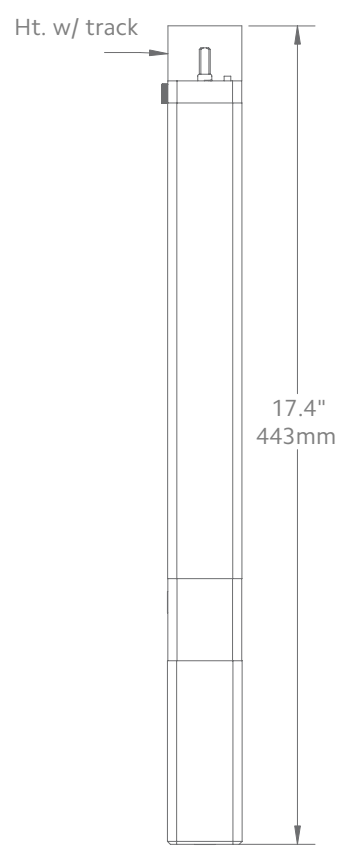

## Bottom View

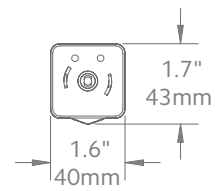

| Motor Unit         | Product No. |
|--------------------|-------------|
| AMP™ Drapery Motor | 62001300    |

| Technical Specs      | AMP™ Motor                                  |
|----------------------|---|
| Power Supply         | DC 16.5V-0.89A<br>(100-240VAC 50/60Hz 0.5A) |
| Amperage             | 2.55Ah                                      |
| Average Linear Speed | 7.8inches/sec                               |
| Power Consumption    | 40 watts                                    |
| Torque               | 1.2Nm                                       |
| Power Cable Length   | 6 feet                                      |
| Variable Speed       | 80, 100 & 120 rpm                           |
| Certifications       | UL/CE                                       |
| Max. Track Length    | Estate™ - 16 ft<br>Architrac™ 94001 - 16 ft |
| Max. Load            | 64 lbs                                      |

Follow track specifications for drapery weight.



# Estate™ Overview

To help determine which system is right for your project, use the guideline below to select the best fit. For more detailed information about each track, please visit our resource library at [kirsch.com](http://kirsch.com).

| Estate™ Series                                      | Designer Metals™ | Wood Trends™ | Wrought Iron | Varia | Chroma |
|---|------------------|--------------|--------------|-------|--------|
| <b>What is your preferred size?</b>                 |                  |              |              |       |        |
| 1 3/8"  | •                | •            | •            |       |        |
| 2"  | •                | •            |              | •     | •      |
| <b>What is your preferred Draw type?</b>            |                  |              |              |       |        |
| Motorized   | •                | •            | •            | •     | •      |
| Manual  | •                | •            | •            | •     | •      |
| <b>What is your preferred Drapery Heading type?</b> |                  |              |              |       |        |
| Pleated   | •                | •            | •            | •     | •      |
| Ripplefold™   | •                | •            | •            | •     | •      |
| <b>What is your mounting location?</b>              |                  |              |              |       |        |
| Ceiling Mount*                                      | •                | •            | •            | •     | •      |
| Wall Mount  | •                | •            | •            | •     | •      |

\*Finial choices may be limited for ceiling mounted Estate™ Rods.

## Track Performance Data

| Style   | Heading Style        | Mount         | Draw    | Minimum Track Length | Maximum Track Length | Minimum Fabric Weight | Lbs. per Ft. |
|---|----------------------|---------------|---------|----------------------|----------------------|-----------------------|--------------|
|  83611<br>1 3/8" Estate™<br>Manual or Motorized Draw | Pleated, Ripplefold™ | Ceiling, Wall | One-Way | 18 in                | 16 ft                | 64 lbs                | 4            |
|   |                      |               | Two-Way | 18 in                | 16 ft                | 64 lbs                | 4            |
|  93601<br>2" Estate™<br>Manual or Motorized Draw     | Pleated, Ripplefold™ | Ceiling, Wall | One-Way | 18 in                | 16 ft                | 64 lbs                | 4            |
|   |                      |               | Two-Way | 18 in                | 16 ft                | 64 lbs                | 4            |

\*Maximum track lengths and maximum fabric weight do not apply to curved track. Check with customer service for feasibility. Send complete specifications and fabric weight.

## Splices & Keystones per Track

| Track Length    | Number of Splices | Keystones Included |
|-----------------|-------------------|--------------------|
| 8 ft. to 16 ft. | 1                 | 1                  |

# Operating Systems

---

## Motorized Draw

### AMP™ Motorization

---

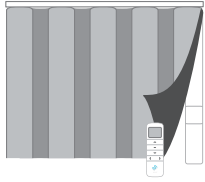

- Easy to use
- Quiet, powerful motor
- Pleated or Ripplefold™
- For Estate™ Traverse Rods or Architrac® Series 94001
- For more information, see page 28

## Manual Draw

### Cord Draw

---

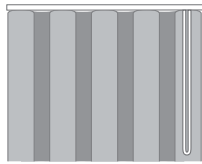

- Easy to use
- Pleated or Ripplefold™

### Hand/Baton Draw

---



- Easy to use
- A gentle tug allows drapery to glide across track
- Pleated or Ripplefold™

### Baton Duplex Draw

---

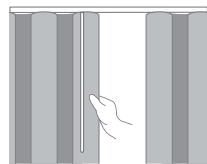

- Easy to use
- Used on split draw rods
- Pleated or Ripplefold™
- When the baton is pulled on one stack, draperies on both sides of the traverse rod open or close

# Header Styles

---

## Ripplefold™

---

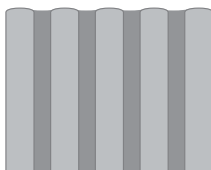

- Panels can be pressed flat, yet fall into fold
- No hooks or pins
- Headings are suspended under track
- Stack back is less than conventional pleated draperies
- Draperies snap on/off carriers for easy installation
- Interior drapery appearance is identical to exterior-facing appearance

## Pleated

---

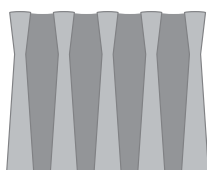

- A classic header option
- Can be used with most track systems using slip-in or pin-on hooks
- Headings can be suspended under the track or over the face of the track to conceal hardware
- Four carriers per foot is standard, additional carriers or rings can be ordered

# Bracket Spacing & Mount Options

Place brackets at each end. On the ends where the drapery will stack, place the next bracket at a maximum of 24" from the first bracket, then place remaining brackets at 48" intervals over the remainder of the track. Spacing may need to be shortened for heavier draperies. All mounting options are compatible with our AMP™ Motorization.



## Wall Mount using parts:

To achieve this look, order Estate rod, wall mount and all components will be included.

94129061  
Zinc



or

1856973  
Satin Nickel



or

1856978  
Brushed Bronze



or

1857324  
Black



## 1 3/8" Wall Mount

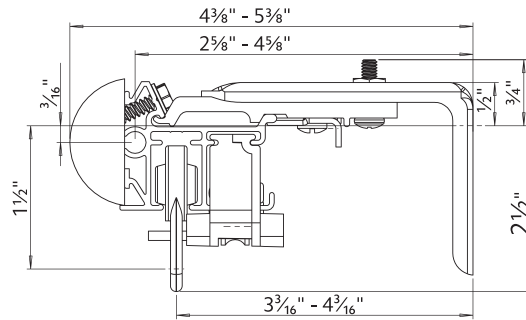

## Ceiling Mount using parts:

To achieve this look, order Estate rod, ceiling mounted. 94130xxx brackets are included with the rod. Then order item 1796061 ceiling mount bracket in the quantity needed based on the bracket spacing drawing on page 32.

94130xxx



&

1796061

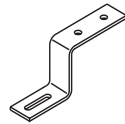

## 1 3/8" Ceiling Mount

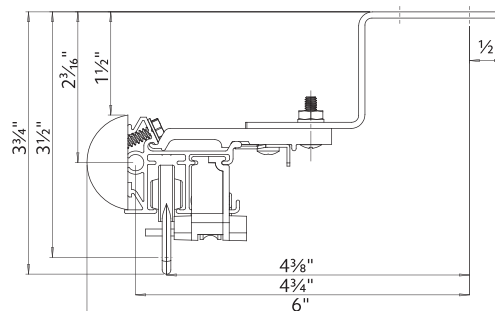



## Double Wall Mount using parts:

To achieve this look, order Estate rod, ceiling mounted. 94130xxx brackets are included with the rod. Then order one, item 94125xxx double bracket and two, item 1796061 ceiling mount brackets multiplied by the quantity needed based on the bracket spacing drawing on page 32.

94125xxx

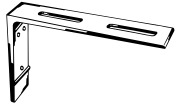

⊗

1796061

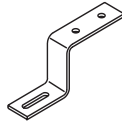

⊗

94130xxx



## 1 3/8" Double Wall Mount

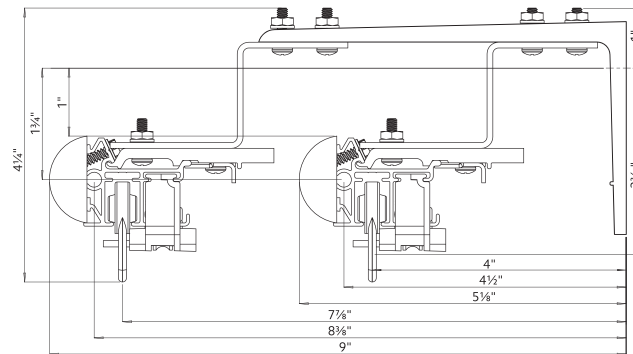

## Double Wall Mount using parts:

To achieve this look, order Estate rod ceiling mounted. 94130xxx brackets are included with the rod. Then order one, item 71134110 double bracket in the quantity needed based on the bracket spacing drawing on page 32.

71134110

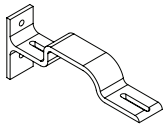

⊗

94130xxx

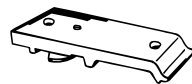

## 1 3/8" Front & 1 3/8" Back Double Wall Mount

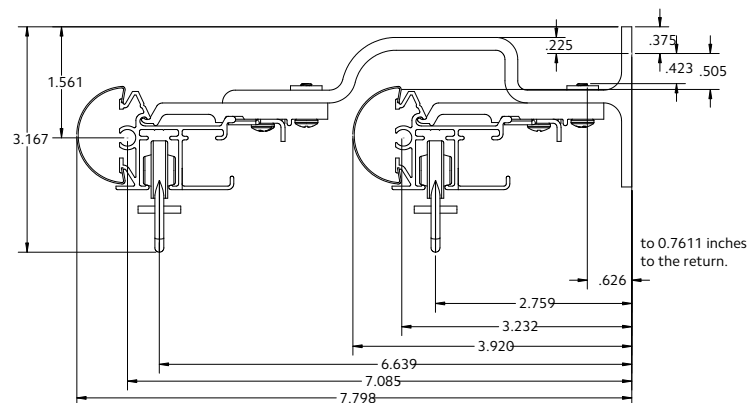

# Calculating Drapery Weight

## 1. Fabric Weight

Some fabric samples list on the back of the swatch the weight listed in Ounces/SqYd (ounces per square yard). Call the manufacturer for the weight if not listed.

## 2. Lining Weight

Most drapery linings are 2oz - 4oz per square yard.

### Drapery Weight Formula

---

**Total Square Yards** = (total yards x 36 x fabric width) ÷ 1296 (1-square yard)

**Weight** = total square yards x weight in ounces per SqYd ÷ 16 oz in lb

**Example** 32 yards of 54" wide fabric weighing 14 oz/SqYd  
Total square yards = (32 x 36 x 54) = 62,208 ÷ 1296 = 48 SqYds  
Weight = (48 x 14oz) = 672 ÷ 16 = 42 lbs

### Lining Weight Formula

---

**Total Square Yards** = (total yards x 36 x fabric width) ÷ 1296 (1-square yard)

**Weight** = total square yards x weight in ounces per SqYd ÷ 16 oz in lb

**Example** 32 yards of 54" wide fabric weighing 6 oz/SqYd  
Total square yards = (32 x 36 x 54) = 62,208 ÷ 1296 = 48 SqYds  
Weight = (48 x 4oz) = 192 ÷ 16 = 12 lbs

## Fabrics by Weight

Contact the fabric manufacturer for your specific fabric weight.

---

| Fabric Type     | Weight per Square Yard |
|-----------------|------------------------|
| Drapery Lining  | 2-4oz                  |
| Interlining     | 5-6oz                  |
| Blackout Lining | 6-10oz                 |
| Bump Lining     | 12-14oz                |
| Silks           | 2-4oz                  |
| Chintz          | 2-4oz                  |
| Printed Cottons | 4-6oz                  |
| Linens          | 6-10oz                 |
| Jacquards       | 10-14oz                |
| Velvets         | 14-18oz                |

---

# Stack Guides

## Pleated Stack Guide (for 16 mm carriers)

Note: Stack size is estimated. Type of fabric used could alter these measurements.

| Size of Track<br>(in inches) | 5 carriers per foot<br>3x fullness |                                    | 4 carriers per foot<br>2½x fullness |                                    | 3 carriers per foot<br>2x fullness |                                    |
|------------------------------|------------------------------------|------------------------------------|-------------------------------------|------------------------------------|------------------------------------|------------------------------------|
|                              | Stackback<br>One-Way               | Stackback<br>Two-Way<br>(per side) | Stackback<br>One-Way                | Stackback<br>Two-Way<br>(per side) | Stackback<br>One-Way               | Stackback<br>Two-Way<br>(per side) |
| 18                           | 11.75                              | 8.75                               | 10.5                                | 8.5                                | 10.5                               | 8.5                                |
| 24                           | 13                                 | 9.25                               | 11.75                               | 8.75                               | 10.5                               | 8.5                                |
| 30                           | 15.75                              | 10.5                               | 13                                  | 9.25                               | 11.75                              | 8.75                               |
| 36                           | 17                                 | 11.25                              | 14.5                                | 10                                 | 13                                 | 9.25                               |
| 42                           | 18.5                               | 12                                 | 15.75                               | 10.5                               | 14.5                               | 10                                 |
| 48                           | 19.75                              | 12.5                               | 17                                  | 11.25                              | 14.5                               | 10                                 |
| 54                           | 22.25                              | 14                                 | 18.5                                | 12                                 | 15.75                              | 10.5                               |
| 60                           | 23.75                              | 14.5                               | 19.75                               | 12.5                               | 17                                 | 11.25                              |
| 66                           | 25                                 | 15.25                              | 21                                  | 13.25                              | 18.5                               | 12                                 |
| 72                           | 26.25                              | 16                                 | 22.25                               | 14                                 | 18.5                               | 12                                 |
| 78                           | 29                                 | 17.25                              | 23.75                               | 14.5                               | 19.75                              | 12.5                               |
| 84                           | 30.25                              | 18                                 | 25                                  | 15.25                              | 21                                 | 13.25                              |
| 90                           | 31.5                               | 18.5                               | 26.25                               | 16                                 | 22.25                              | 14                                 |
| 96                           | 33                                 | 19.25                              | 27.5                                | 16.5                               | 22.25                              | 14                                 |
| 102                          | 35.5                               | 20.5                               | 29                                  | 17.25                              | 23.75                              | 14.5                               |
| 108                          | 36.75                              | 21.25                              | 30.25                               | 18                                 | 25                                 | 15.25                              |
| 114                          | 38.25                              | 21.75                              | 31.5                                | 18.5                               | 26.25                              | 16                                 |
| 120                          | 39.5                               | 22.5                               | 33                                  | 19.25                              | 26.25                              | 16                                 |
| 126                          | 42.25                              | 23.75                              | 34.25                               | 19.75                              | 27.5                               | 16.5                               |
| 132                          | 43.5                               | 24.5                               | 35.5                                | 20.5                               | 29                                 | 17.25                              |
| 138                          | 44.75                              | 25.25                              | 36.75                               | 21.25                              | 30.25                              | 18                                 |
| 144                          | 46                                 | 25.75                              | 38.25                               | 21.75                              | 30.25                              | 18                                 |
| 150                          | 48.75                              | 27                                 | 39.5                                | 22.5                               | 31.5                               | 18.5                               |
| 156                          | 50                                 | 27.75                              | 40.75                               | 23.25                              | 33                                 | 19.25                              |
| 162                          | 51.5                               | 28.5                               | 42.25                               | 23.75                              | 34.25                              | 19.75                              |
| 168                          | 52.75                              | 29                                 | 43.5                                | 24.5                               | 34.25                              | 19.75                              |
| 174                          | 55.25                              | 30.5                               | 44.75                               | 25.25                              | 35.5                               | 20.5                               |
| 180                          | 56.75                              | 31                                 | 46                                  | 25.75                              | 36.75                              | 21.25                              |
| 186                          | 58                                 | 31.75                              | 47.5                                | 26.5                               | 38.25                              | 21.75                              |
| 192                          | 59.25                              | 32.5                               | 48.75                               | 27                                 | 38.25                              | 21.75                              |
| 198                          | 62                                 | 33.75                              | 50                                  | 27.75                              | 39.5                               | 22.5                               |
| 204                          | 63.25                              | 34.5                               | 51.5                                | 28.5                               | 40.75                              | 23.25                              |
| 210                          | 64.5                               | 35                                 | 52.75                               | 29                                 | 42.25                              | 23.75                              |
| 216                          | 66                                 | 35.75                              | 54                                  | 29.75                              | 42.25                              | 23.75                              |
| 222                          | 68.5                               | 37                                 | 55.25                               | 30.5                               | 43.5                               | 24.5                               |
| 228                          | 69.75                              | 37.75                              | 56.75                               | 31                                 | 44.75                              | 25.25                              |
| 234                          | 71.25                              | 38.25                              | 58                                  | 31.75                              | 46                                 | 25.75                              |
| 240                          | 72.5                               | 39                                 | 59.25                               | 32.5                               | 46                                 | 25.75                              |

# Ripplefold™ Stack Guide for Butt Master 84111xxx

Note: Stack size is estimated. Type of fabric used could alter these measurements. Please refer to the Ripplefold Fabrication Manual for more information.

| 120% Fullness | 100% Fullness | 80% Fullness | 60% Fullness | Number of factory snaps | Snap Tape Length (less return length)* | Panel Stackback |
|---------------|---------------|--------------|--------------|-------------------------|--|-----------------|
| 13⅜           | 15⅜           | 17⅞          | 18⅞          | 8                       | 32½                                    | 5½              |
| 17⅜           | 19⅝           | 21⅞          | 24⅞          | 10                      | 41                                     | 6½              |
| 21⅞           | 23⅞           | 26⅞          | 29⅞          | 12                      | 49½                                    | 7½              |
| 24⅞           | 28⅞           | 31⅞          | 34⅞          | 14                      | 58                                     | 8¾              |
| 28⅞           | 32⅞           | 36⅞          | 39⅞          | 16                      | 66½                                    | 9¾              |
| 32⅞           | 36⅞           | 40⅞          | 45⅞          | 18                      | 75                                     | 11              |
| 36⅞           | 40⅞           | 45⅞          | 50⅞          | 20                      | 83½                                    | 12              |
| 39⅞           | 45⅞           | 50⅞          | 55⅞          | 22                      | 92                                     | 13              |
| 45⅞           | 49⅞           | 55⅞          | 60⅞          | 24                      | 100½                                   | 14¼             |
| 47⅞           | 53⅞           | 59⅞          | 66⅞          | 26                      | 109                                    | 15¼             |
| 51⅞           | 57⅞           | 64⅞          | 71⅞          | 28                      | 117½                                   | 16½             |
| 54⅞           | 62⅞           | 69⅞          | 76⅞          | 30                      | 126                                    | 17½             |
| 58⅞           | 66⅞           | 74⅞          | 81⅞          | 32                      | 134½                                   | 18½             |
| 62⅞           | 70⅞           | 78⅞          | 87⅞          | 34                      | 143                                    | 19¾             |
| 66⅞           | 74⅞           | 83⅞          | 92⅞          | 36                      | 151½                                   | 20¾             |
| 69⅞           | 79⅞           | 88⅞          | 97⅞          | 38                      | 160                                    | 22              |
| 73⅞           | 83⅞           | 93⅞          | 102⅞         | 40                      | 168½                                   | 23              |
| 77⅞           | 87⅞           | 97⅞          | 108⅞         | 42                      | 177                                    | 24              |
| 81⅞           | 91⅞           | 102⅞         | 113⅞         | 44                      | 185½                                   | 25¼             |
| 84⅞           | 96⅞           | 107⅞         | 118⅞         | 46                      | 194                                    | 26¼             |
| 88⅞           | 100⅞          | 112⅞         | 123⅞         | 48                      | 202½                                   | 27½             |
| 92⅞           | 104⅞          | 116⅞         | 129⅞         | 50                      | 211                                    | 28½             |
| 96⅞           | 108⅞          | 121⅞         | 134⅞         | 52                      | 219½                                   | 29½             |
| 99⅞           | 113⅞          | 126⅞         | 139⅞         | 52                      | 228                                    | 30¾             |
| 103⅞          | 117⅞          | 131⅞         | 144⅞         | 54                      | 236½                                   | 31¾             |
| 107⅞          | 121⅞          | 135⅞         | 150⅞         | 56                      | 245                                    | 33              |
| 111⅞          | 125⅞          | 140⅞         | 155⅞         | 58                      | 253½                                   | 34              |
| 114⅞          | 130⅞          | 145⅞         | 160⅞         | 60                      | 262                                    | 35              |
| 118⅞          | 134⅞          | 150⅞         | 165⅞         | 62                      | 270½                                   | 36¼             |
| 122⅞          | 138⅞          | 154⅞         | 171⅞         | 64                      | 279                                    | 37¼             |
| 126⅞          | 142⅞          | 159⅞         | 176⅞         | 66                      | 287½                                   | 38½             |
| 129⅞          | 147⅞          | 164⅞         | 181⅞         | 68                      | 296                                    | 39 ½            |
| 133⅞          | 151⅞          | 169⅞         | 186⅞         | 70                      | 304½                                   | 40½             |
| 137⅞          | 155⅞          | 173⅞         | 192⅞         | 72                      | 313                                    | 41¾             |
| 141⅞          | 159⅞          | 178⅞         | 197⅞         | 74                      | 321½                                   | 42¾             |
| 144⅞          | 164⅞          | 183⅞         | 202⅞         | 76                      | 330                                    | 44              |

# Ripplefold™ Stack Guide for Butt Master 8411xxx

Note: Stack size is estimated. Type of fabric used could alter these measurements. Please refer to the Ripplefold Fabrication Manual for more information.

| 120% Fullness | 100% Fullness | 80% Fullness | 60% Fullness | Number of factory snaps | Snap Tape Length (less return length)* | Panel Stackback |
|---------------|---------------|--------------|--------------|-------------------------|--|-----------------|
| 148⅝          | 168⅝          | 188⅝         | 207⅝         | 78                      | 338½                                   | 45              |
| 152⅝          | 176⅝          | 192⅝         | 213⅝         | 80                      | 347                                    | 46              |
| 156⅝          | 176⅝          | 197⅝         | 218⅝         | 84                      | 355½                                   | 47¼             |
| 159⅝          | 181⅝          | 202⅝         | 223⅝         | 86                      | 364                                    | 48¼             |
| 163⅝          | 185⅝          | 207⅝         | 228⅝         | 88                      | 372½                                   | 49½             |
| 167⅝          | 189⅝          | 211⅝         | 234⅝         | 90                      | 381                                    | 50½             |
| 171⅝          | 193⅝          | 216⅝         | 239⅝         | 92                      | 389½                                   | 51½             |
| 174⅝          | 198⅝          | 221⅝         | 244⅝         | 94                      | 398                                    | 52¾             |
| 178⅝          | 202⅝          | 226⅝         | 249⅝         | 96                      | 406½                                   | 53¾             |
| 182⅝          | 206⅝          | 230⅝         | 255⅝         | 98                      | 415                                    | 55              |
| 186⅝          | 210⅝          | 235⅝         | 260⅝         | 100                     | 423½                                   | 56              |
| 189⅝          | 215⅝          | 240⅝         | 265⅝         | 102                     | 432                                    | 57              |
| 193⅝          | 219⅝          | 245⅝         | 270⅝         | 104                     | 440½                                   | 58¼             |
| 197⅝          | 223⅝          | 249⅝         | 276⅝         | 106                     | 449                                    | 59¼             |
| 201⅝          | 227⅝          | 254⅝         | 281⅝         | 108                     | 457½                                   | 60½             |
| 204⅝          | 232⅝          | 259⅝         | 286⅝         | 110                     | 466                                    | 61½             |
| 208⅝          | 236⅝          | 264⅝         | 291⅝         | 112                     | 474½                                   | 62 ½            |
| 212⅝          | 240⅝          | 268⅝         | 297⅝         | 114                     | 483                                    | 63¾             |
| 216⅝          | 244⅝          | 273⅝         | 302⅝         | 116                     | 491½                                   | 64¾             |
| 219⅝          | 249⅝          | 278⅝         | 307⅝         | 118                     | 500                                    | 66              |
| 223⅝          | 253⅝          | 283⅝         | 312⅝         | 120                     | 508½                                   | 67              |
| 227⅝          | 257⅝          | 287⅝         | 318⅝         | 122                     | 517                                    | 68              |
| 231⅝          | 261⅝          | 292⅝         | 323⅝         | 124                     | 525½                                   | 69¼             |
| 234⅝          | 266⅝          | 297⅝         | 328⅝         | 126                     | 534                                    | 70¼             |
| 238⅝          | 270⅝          | 302⅝         | 333⅝         | 128                     | 542½                                   | 71½             |
| 242⅝          | 274⅝          | 306⅝         | 339⅝         | 130                     | 551                                    | 72½             |
| 246⅝          | 278⅝          | 311⅝         | 344⅝         | 132                     | 559½                                   | 73½             |
| 249⅝          | 283⅝          | 316⅝         | 349⅝         | 134                     | 568                                    | 74¾             |
| 253⅝          | 287⅝          | 321⅝         | 354⅝         | 136                     | 576½                                   | 75¾             |
| 257⅝          | 291⅝          | 325⅝         | 360⅝         | 138                     | 585                                    | 77              |
| 261⅝          | 295⅝          | 330⅝         | 365⅝         | 140                     | 593½                                   | 78              |
| 264⅝          | 300⅝          | 335⅝         | 370⅝         | 142                     | 602                                    | 79              |
| 268⅝          | 304⅝          | 340⅝         | 375⅝         | 144                     | 610½                                   | 80¼             |
| 272⅝          | 308⅝          | 344⅝         | 381⅝         | 146                     | 619                                    | 81¼             |
| 276⅝          | 312⅝          | 349⅝         | 386⅝         | 148                     | 627½                                   | 82½             |
| 279⅝          | 317⅝          | 354⅝         | 391⅝         | 150                     | 636                                    | 83½             |

# Ripplefold™ Stack Guide for Butt Master 84214xxx

Note: Stack size is estimated. Type of fabric used could alter these measurements. Please refer to the Ripplefold Fabrication Manual for more information.

| 120% Fullness | 100% Fullness | 80% Fullness | 60% Fullness | Number of factory snaps | Snap Tape Length (less return length)* | Panel Stackback |
|---------------|---------------|--------------|--------------|-------------------------|--|-----------------|
| 14⅞           | 16⅜           | 17⅞          | 19⅜          | 8                       | 32½                                    | 7½              |
| 18⅞           | 20⅞           | 22⅞          | 24⅞          | 10                      | 41                                     | 8½              |
| 22⅞           | 24⅞           | 27⅞          | 29⅞          | 12                      | 49½                                    | 9¾              |
| 26⅞           | 29⅞           | 32⅞          | 35⅞          | 14                      | 58                                     | 10¾             |
| 29⅞           | 33⅞           | 36⅞          | 40⅞          | 16                      | 66½                                    | 12              |
| 33⅞           | 37⅞           | 41⅞          | 45⅞          | 18                      | 75                                     | 13              |
| 37⅞           | 41⅞           | 46⅞          | 50⅞          | 20                      | 83½                                    | 14              |
| 41⅞           | 46⅞           | 51⅞          | 56⅞          | 22                      | 92                                     | 15¼             |
| 44⅞           | 50⅞           | 55⅞          | 61⅞          | 24                      | 100½                                   | 16¼             |
| 48⅞           | 54⅞           | 60⅞          | 66⅞          | 26                      | 109                                    | 17½             |
| 52⅞           | 58⅞           | 65⅞          | 71⅞          | 28                      | 117½                                   | 18½             |
| 56⅞           | 63⅞           | 70⅞          | 77⅞          | 30                      | 126                                    | 19½             |
| 59⅞           | 67⅞           | 74⅞          | 82⅞          | 32                      | 134½                                   | 20¾             |
| 63⅞           | 71⅞           | 79⅞          | 87⅞          | 34                      | 143                                    | 21¾             |
| 67⅞           | 75⅞           | 84⅞          | 92⅞          | 36                      | 151½                                   | 23              |
| 71⅞           | 80⅞           | 89⅞          | 98⅞          | 38                      | 160                                    | 24              |
| 74⅞           | 84⅞           | 93⅞          | 103⅞         | 40                      | 168½                                   | 25              |
| 78⅞           | 88⅞           | 98⅞          | 108⅞         | 42                      | 177                                    | 26¼             |
| 82⅞           | 92⅞           | 103⅞         | 113⅞         | 44                      | 185½                                   | 27¼             |
| 86⅞           | 97⅞           | 108⅞         | 119⅞         | 46                      | 194                                    | 28½             |
| 89⅞           | 101⅞          | 112⅞         | 124⅞         | 48                      | 202½                                   | 29½             |
| 93⅞           | 105⅞          | 117⅞         | 129⅞         | 50                      | 211                                    | 30½             |
| 97⅞           | 109⅞          | 122⅞         | 134⅞         | 52                      | 219½                                   | 31¾             |
| 101⅞          | 114⅞          | 127⅞         | 140⅞         | 54                      | 228                                    | 32¾             |
| 104⅞          | 118⅞          | 131⅞         | 145⅞         | 56                      | 236½                                   | 34              |
| 108⅞          | 122⅞          | 136⅞         | 150⅞         | 56                      | 245                                    | 35              |
| 112⅞          | 126⅞          | 141⅞         | 155⅞         | 60                      | 253½                                   | 36¼             |
| 116⅞          | 131⅞          | 146⅞         | 161⅞         | 62                      | 262                                    | 37¼             |
| 119⅞          | 135⅞          | 150⅞         | 166⅞         | 64                      | 270½                                   | 38¼             |
| 123⅞          | 139⅞          | 155⅞         | 171⅞         | 66                      | 279                                    | 39½             |
| 127⅞          | 143⅞          | 160⅞         | 176⅞         | 68                      | 287½                                   | 40½             |
| 131⅞          | 148⅞          | 165⅞         | 182⅞         | 70                      | 296                                    | 41¾             |
| 134⅞          | 152⅞          | 169⅞         | 187⅞         | 72                      | 304½                                   | 42¾             |
| 138⅞          | 156⅞          | 174⅞         | 192⅞         | 74                      | 313                                    | 43¾             |
| 142⅞          | 160⅞          | 179⅞         | 197⅞         | 76                      | 321½                                   | 45              |
| 146⅞          | 165⅞          | 184⅞         | 203⅞         | 78                      | 330                                    | 46              |

# Ripplefold™ Stack Guide for Butt Master 84214xxx

Note: Stack size is estimated. Type of fabric used could alter these measurements. Please refer to the Ripplefold Fabrication Manual for more information.

| 120% Fullness | 100% Fullness | 80% Fullness | 60% Fullness | Number of factory snaps | Snap Tape Length (less return length)* | Panel Stackback |
|---------------|---------------|--------------|--------------|-------------------------|--|-----------------|
| 149⅞          | 169⅞          | 188⅞         | 208⅞         | 80                      | 338½                                   | 47¼             |
| 153⅞          | 173⅞          | 193⅞         | 213⅞         | 82                      | 347                                    | 48¼             |
| 157⅞          | 177⅞          | 198⅞         | 218⅞         | 84                      | 355½                                   | 49½             |
| 161⅞          | 182⅞          | 203⅞         | 224⅞         | 86                      | 364                                    | 50½             |
| 164⅞          | 186⅞          | 207⅞         | 229⅞         | 88                      | 372½                                   | 51½             |
| 168⅞          | 190⅞          | 212⅞         | 234⅞         | 90                      | 381                                    | 52¾             |
| 172⅞          | 194⅞          | 217⅞         | 239⅞         | 92                      | 389½                                   | 53¾             |
| 176⅞          | 199⅞          | 222⅞         | 245⅞         | 94                      | 398                                    | 55              |
| 179⅞          | 203⅞          | 226⅞         | 250⅞         | 96                      | 406½                                   | 56              |
| 183⅞          | 207⅞          | 231⅞         | 255⅞         | 98                      | 415                                    | 57              |
| 187⅞          | 211⅞          | 236⅞         | 260⅞         | 100                     | 423½                                   | 58¼             |
| 191⅞          | 216⅞          | 241⅞         | 266⅞         | 102                     | 432                                    | 59¼             |
| 194⅞          | 220⅞          | 245⅞         | 271⅞         | 104                     | 440½                                   | 60½             |
| 198⅞          | 224⅞          | 250⅞         | 276⅞         | 106                     | 449                                    | 61½             |
| 202⅞          | 228⅞          | 255⅞         | 281⅞         | 108                     | 457½                                   | 62½             |
| 206⅞          | 233⅞          | 260⅞         | 287⅞         | 110                     | 466                                    | 63¾             |
| 209⅞          | 237⅞          | 264⅞         | 292⅞         | 112                     | 474½                                   | 64¾             |
| 213⅞          | 241⅞          | 269⅞         | 297⅞         | 114                     | 483                                    | 66              |
| 217⅞          | 245⅞          | 274⅞         | 302⅞         | 116                     | 491½                                   | 67              |
| 221⅞          | 250⅞          | 279⅞         | 308⅞         | 118                     | 500                                    | 68¼             |
| 224⅞          | 254⅞          | 283⅞         | 313⅞         | 120                     | 508½                                   | 69¼             |
| 228⅞          | 258⅞          | 288⅞         | 318⅞         | 122                     | 517                                    | 70¼             |
| 232⅞          | 262⅞          | 293⅞         | 323⅞         | 124                     | 525½                                   | 71½             |
| 236⅞          | 267⅞          | 298⅞         | 329⅞         | 126                     | 534                                    | 72½             |
| 239⅞          | 271⅞          | 302⅞         | 334⅞         | 128                     | 542½                                   | 73¾             |
| 243⅞          | 275⅞          | 307⅞         | 339⅞         | 130                     | 551                                    | 74¾             |
| 247⅞          | 279⅞          | 312⅞         | 344⅞         | 132                     | 559½                                   | 75¾             |
| 251⅞          | 284⅞          | 317⅞         | 350⅞         | 134                     | 568                                    | 77              |
| 254⅞          | 288⅞          | 321⅞         | 355⅞         | 136                     | 576½                                   | 78              |
| 258⅞          | 292⅞          | 326⅞         | 360⅞         | 138                     | 585                                    | 79¼             |
| 262⅞          | 296⅞          | 331⅞         | 365⅞         | 140                     | 593½                                   | 80¼             |
| 266⅞          | 301⅞          | 336⅞         | 371⅞         | 142                     | 602                                    | 81¼             |
| 269⅞          | 305⅞          | 340⅞         | 376⅞         | 144                     | 610½                                   | 82½             |
| 273⅞          | 309⅞          | 345⅞         | 381⅞         | 146                     | 619                                    | 83½             |
| 277⅞          | 313⅞          | 350⅞         | 386⅞         | 148                     | 627½                                   | 84¾             |
| 281⅞          | 318⅞          | 355⅞         | 392⅞         | 150                     | 636                                    | 85¾             |

# Ripplefold™ Overlap Stack Guide

Note: Stack size is estimated. Type of fabric used could alter these measurements. Please refer to the Ripplefold Fabrication Manual for more information.

| 120% Fullness | 100% Fullness | 80% Fullness | 60% Fullness | Number of factory snaps | Snap Tape Length (less return length)* | Panel Stackback |
|---------------|---------------|--------------|--------------|-------------------------|--|-----------------|
| 16¼           | 17¾           | 19⅞          | 20¾          | 8                       | 34                                     | 9               |
| 20            | 22            | 23⅞          | 26           | 10                      | 42½                                    | 10¼             |
| 23¾           | 26¼           | 28⅞          | 31¼          | 12                      | 51                                     | 11¼             |
| 27½           | 20½           | 33⅞          | 26½          | 14                      | 59½                                    | 12½             |
| 31¼           | 34¾           | 38⅞          | 41¾          | 16                      | 68                                     | 13½             |
| 35            | 39            | 42⅞          | 47           | 18                      | 76½                                    | 14½             |
| 38¾           | 43¼           | 47⅞          | 52¼          | 20                      | 85                                     | 15¾             |
| 42½           | 47½           | 52⅞          | 57½          | 22                      | 93½                                    | 16¾             |
| 46¼           | 51¾           | 57⅞          | 62¾          | 24                      | 102                                    | 18              |
| 50            | 56            | 61⅞          | 68           | 26                      | 110½                                   | 19              |
| 53¾           | 60¼           | 66⅞          | 73¼          | 28                      | 119                                    | 20              |
| 57½           | 64½           | 71⅞          | 78½          | 30                      | 127½                                   | 21¼             |
| 61¼           | 68¾           | 76⅞          | 83¾          | 32                      | 136                                    | 22¼             |
| 65            | 73            | 80⅞          | 89           | 34                      | 144½                                   | 23½             |
| 68¾           | 77¼           | 85⅞          | 94¼          | 36                      | 153                                    | 24½             |
| 72½           | 81½           | 90⅞          | 99½          | 38                      | 161½                                   | 25½             |
| 76¼           | 85¾           | 95⅞          | 104¾         | 40                      | 170                                    | 26¾             |
| 80            | 90            | 99⅞          | 110          | 42                      | 178½                                   | 27¾             |
| 83¾           | 94¼           | 104⅞         | 115¼         | 44                      | 187                                    | 29              |
| 87½           | 98½           | 109⅞         | 120½         | 46                      | 195½                                   | 30              |
| 91¼           | 102¾          | 114⅞         | 125¾         | 48                      | 204                                    | 31              |
| 95            | 107           | 118⅞         | 131          | 50                      | 212½                                   | 32¼             |
| 98¾           | 111¼          | 123⅞         | 136¼         | 52                      | 221                                    | 33¼             |
| 102½          | 115½          | 128⅞         | 141½         | 54                      | 229½                                   | 34½             |
| 106¼          | 119¾          | 133⅞         | 146¾         | 56                      | 238                                    | 35½             |
| 110           | 124           | 137⅞         | 152          | 56                      | 246½                                   | 36½             |
| 113¾          | 128¼          | 142⅞         | 157¼         | 60                      | 255                                    | 37¾             |
| 117½          | 132½          | 147⅞         | 162½         | 62                      | 263½                                   | 38¾             |
| 121¼          | 136¾          | 152⅞         | 167¾         | 64                      | 272                                    | 40              |
| 125           | 141           | 156⅞         | 173          | 66                      | 280½                                   | 41              |
| 128¾          | 145¼          | 161⅞         | 178¼         | 68                      | 289                                    | 42              |
| 132½          | 149½          | 166⅞         | 183½         | 70                      | 297½                                   | 43¼             |
| 136¼          | 153¾          | 171⅞         | 188¾         | 72                      | 306                                    | 44¼             |
| 140           | 158           | 175⅞         | 194          | 74                      | 314½                                   | 45½             |
| 143¾          | 162¼          | 180⅞         | 199¼         | 76                      | 323                                    | 46½             |
| 147½          | 166½          | 185⅞         | 204½         | 78                      | 331½                                   | 47½             |



# Ripplefold™ Overlap Stack Guide

Note: Stack size is estimated. Type of fabric used could alter these measurements. Please refer to the Ripplefold Fabrication Manual for more information.

| 120% Fullness | 100% Fullness | 80% Fullness | 60% Fullness | Number of factory snaps | Snap Tape Length (less return length)* | Panel Stackback |
|---------------|---------------|--------------|--------------|-------------------------|--|-----------------|
| 151¼          | 170¼          | 190½         | 209¾         | 80                      | 340                                    | 48¾             |
| 155           | 175           | 194¾         | 215          | 82                      | 348½                                   | 49¾             |
| 158¾          | 179¼          | 199½         | 220¼         | 84                      | 357                                    | 51              |
| 162½          | 183½          | 204¾         | 225½         | 86                      | 365½                                   | 52              |
| 166¼          | 187¾          | 209½         | 230¾         | 88                      | 374                                    | 53              |
| 170           | 192           | 213¾         | 236          | 90                      | 382½                                   | 54¼             |
| 173¾          | 196¼          | 218½         | 241¼         | 92                      | 391                                    | 55¼             |
| 177½          | 200½          | 223¾         | 246½         | 94                      | 399½                                   | 56½             |
| 181¼          | 204¾          | 228½         | 251¾         | 96                      | 408                                    | 57½             |
| 185           | 209           | 232¾         | 257          | 98                      | 416½                                   | 58½             |
| 188¾          | 213¼          | 237½         | 262¼         | 100                     | 425                                    | 59¾             |
| 192½          | 217½          | 242¾         | 267½         | 102                     | 433½                                   | 60¾             |
| 196¼          | 221¾          | 247½         | 272¾         | 104                     | 442                                    | 62              |
| 200           | 226           | 251¾         | 278          | 106                     | 450½                                   | 63              |
| 203¾          | 230¼          | 256½         | 283¼         | 108                     | 459                                    | 64              |
| 207½          | 234½          | 261¾         | 288½         | 110                     | 467½                                   | 65¼             |
| 211¼          | 238¾          | 266½         | 293¾         | 112                     | 476                                    | 66¼             |
| 215           | 243           | 270¾         | 299          | 114                     | 484½                                   | 67½             |
| 218¾          | 247¼          | 275½         | 304¼         | 116                     | 493                                    | 68½             |
| 222½          | 251½          | 280¾         | 309½         | 118                     | 501½                                   | 69½             |
| 226¼          | 255¾          | 285½         | 314¾         | 120                     | 510                                    | 70¾             |
| 230           | 260           | 289¾         | 320          | 122                     | 518½                                   | 71¾             |
| 233¾          | 264¼          | 294½         | 325¼         | 124                     | 527                                    | 73              |
| 237½          | 268½          | 299¾         | 330½         | 126                     | 535½                                   | 74              |
| 241¼          | 272¾          | 304½         | 335¾         | 128                     | 544                                    | 75              |
| 245           | 277           | 308¾         | 341          | 130                     | 552½                                   | 76¼             |
| 248¾          | 281¼          | 313½         | 346¼         | 132                     | 561                                    | 77¼             |
| 252½          | 285½          | 318¾         | 351½         | 134                     | 569½                                   | 78½             |
| 256¼          | 289¾          | 323½         | 356¾         | 136                     | 578                                    | 79½             |
| 260           | 294           | 327¾         | 362          | 138                     | 586½                                   | 80½             |
| 263¾          | 298¼          | 332½         | 367¼         | 140                     | 595                                    | 81¾             |
| 267½          | 302½          | 337¾         | 372½         | 142                     | 603½                                   | 82¾             |
| 271¼          | 306¾          | 342½         | 377¾         | 144                     | 612                                    | 84              |
| 275           | 311           | 346¾         | 383          | 146                     | 620½                                   | 85              |
| 278¾          | 315¼          | 351½         | 388¼         | 148                     | 629                                    | 86              |
| 282½          | 319½          | 356¾         | 393½         | 150                     | 637½                                   | 87¼             |

# Pole Installation, Cutting & Splicing

## Top Hole Installation Guide

This chart will position the bracket so the drapery will clear the floor approximately ½".

1. Find your pole style, size and header style in the chart.
2. Determine the desired finished drapery length.
3. Add or subtract number in the top hole column from the drapery's finished length to determine how high to measure for the top hole of the bracket.

| Stationary Poles           |                               |  |  |                          |         |
|----------------------------|-------------------------------|--|--|--------------------------|---------|
|                            | Rod Pocket<br>(no top ruffle) |  |  | Pleated<br>(any variety) |         |
|                            | Top Hole                      |  |  | Top Hole                 | Pin Set |
| <b>1" Standard Bracket</b> | +¾"                           |  |  | +2⅝"                     | ¼"      |

| Wall Mount Traverse Rods |                                    |                                  |                      |                                    |                                  |
|--------------------------|------------------------------------|----------------------------------|----------------------|------------------------------------|----------------------------------|
|                          | Pleated<br>(any variety)           |                                  |                      | Ripplefold™<br>(any fullness)      |                                  |
|                          | Top Hole<br>for Wall<br>Mount      | Floor to<br>Ceiling<br>Deduction | Suggested<br>Pin Set | Top Hole<br>for Wall<br>Mount      | Floor to<br>Ceiling<br>Deduction |
| <b>1⅜" Estate™</b>       | +1 <sup>11</sup> / <sub>16</sub> " | -2 <sup>1</sup> / <sub>8</sub> " | ½"                   | +1 <sup>11</sup> / <sub>16</sub> " | -2 <sup>1</sup> / <sub>8</sub> " |

| Ceiling Mount Traverse Rods |     |                                  |    |     |                                  |
|-----------------------------|-----|----------------------------------|----|-----|----------------------------------|
| <b>1⅜" Estate™</b>          | +0" | -3 <sup>5</sup> / <sub>8</sub> " | ½" | +0" | -3 <sup>5</sup> / <sub>8</sub> " |

## Cutting & Splicing Wrought Iron Poles

- Measure to desired length and carefully wrap area with an easy peel, blue painter's tape as not to damage the finish.
- Cut through the tape with sharp fine tooth saw or a pipe cutter with a stainless steel blade. Cut slowly to reduce any chipping to the product finish.
- For spliced poles, add a finial plug to the end cut.
- Splice fits inside the pole and is specific to the pole diameter.



**Finial Plug**  
Part #56369058  
or #56469058



**Splice**  
Part #56366061  
or #56466061

# Learn more about all of our collections

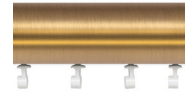

|                                | <b>Designer Metals™<br/>Collection</b>                          | <b>Wood Trends™<br/>Collection</b>                            | <b>Wrought Iron<br/>Collection</b>                                 | <b>Estate™<br/>Traverse Rods<br/>Collection</b>   |
|--------------------------------|---|---|--|---|
|                                | sophisticated styles<br>acrylic and metals<br>striking finishes | crafted timelessness<br>beautiful finishes<br>classic designs | architectural statement<br>remarkable history<br>real wrought iron | form meets function<br>innovative solutions<br>customizable   |
| <b>Available<br/>Diameters</b> | 1" 1 $\frac{3}{8}$ " & 2"                                       | 1 $\frac{3}{8}$ " & 2"  | 1" & 1 $\frac{3}{8}$ "   | 1 $\frac{3}{8}$ "<br>Wrought Iron<br><br>1 $\frac{3}{8}$ " & 2"<br>Designer Metals™<br>Wood Trends™<br><br>2"<br>Varia & Chroma |
| <b>Pole<br/>Lengths</b>        | Fixed - 4', 6' & 8'<br>Telescoping - 36"-180"                   | 4', 6', 8', 12'   | 6' & 8'  | 18"-16'   |
| <b>Pole<br/>Material</b>       | Metal   | Wood  | Metal  | Wood, Metal,<br>Varia & Chroma  |
| <b>Operation<br/>Modes</b>     | Stationary,<br>Traversing Manual<br>or Motorized Draw           | Stationary,<br>Traversing Manual<br>or Motorized Draw         | Stationary,<br>Traversing Manual<br>or Motorized Draw              | Traversing Manual<br>or Motorized Draw  |
| <b>Pole<br/>Sizing</b>         | Fixed Width<br>& Telescoping                                    | Fixed Width   | Fixed Width  | Cut to Measure  |
| <b>Finishes</b>                | 8   | 9   | 6  | 62  |
| <b>Finials</b>                 | 27  | 18  | 18   | 106   |
| <b>Bracket<br/>Types</b>       | Decorative Fixed<br>& Bypass Fixed                              | Decorative Fixed  | Decorative Fixed<br>& Bypass Fixed                                 | Concealed Adjustable  |
| <b>Bracket<br/>Sizes</b>       | 3" – 8 $\frac{3}{4}$ ",<br>Inside Mount<br>& Ceiling Mount      | 3 $\frac{1}{2}$ " – 7",<br>Inside Mount<br>& Ceiling Mount    | 3 $\frac{1}{2}$ " – 6 $\frac{1}{2}$ "<br>& Inside Mount            | 1 $\frac{3}{4}$ " – 3 $\frac{1}{4}$ "   |
| <b>Treatment<br/>Styles</b>    | Stationary<br>& Traversing                                      | Stationary<br>& Traversing                                    | Stationary<br>& Traversing   | Traversing  |



Designer Metals | 1" Soren in Gilded Bronze, Brushed Bronze & Elegant Brass



Wood Trends | Chaucer in Estate Oak, Black



Wrought Iron | Darby in Graphite, Heirloom Copper

| PRODUCT NO. | PAGE | PRODUCT NO. | PAGE | PRODUCT NO. | PAGE | PRODUCT NO. | PAGE |
|-------------|------|-------------|------|-------------|------|-------------|------|
| 1026660     | 25   | 56374802    | 11   | 56376804    | 28   | 56460803    | 23   |
| 1026661     | 25   | 56375770    | 17   | 56376805    | 28   | 56460804    | 23   |
| 1026662     | 25   | 56375777    | 17   | 56381770    | 8    | 56460805    | 23   |
| 1026663     | 25   | 56375802    | 17   | 56381777    | 8    | 56461770    | 26   |
| 1833770     | 22   | 56351803    | 11   | 56381802    | 8    | 56461777    | 26   |
| 1833777     | 22   | 56351804    | 11   | 56381803    | 8    | 56461802    | 26   |
| 1833802     | 22   | 56351805    | 11   | 56381804    | 8    | 56461803    | 26   |
| 1833803     | 22   | 56358803    | 12   | 56381805    | 8    | 56461804    | 26   |
| 1833804     | 22   | 56358804    | 12   | 56382770    | 8    | 56461805    | 26   |
| 1833805     | 22   | 56358805    | 12   | 56382777    | 8    | 56462770    | 27   |
| 56351770    | 11   | 56359803    | 13   | 56382802    | 8    | 56462777    | 27   |
| 56351777    | 11   | 56359804    | 13   | 56382803    | 8    | 56462802    | 27   |
| 56351802    | 11   | 56359805    | 13   | 56382804    | 8    | 56462803    | 27   |
| 56358770    | 12   | 56360803    | 13   | 56382805    | 8    | 56462804    | 27   |
| 56358777    | 12   | 56360804    | 13   | 56383770    | 8    | 56462805    | 27   |
| 56358802    | 12   | 56360805    | 13   | 56383777    | 8    | 56463770    | 27   |
| 56359770    | 13   | 56361803    | 14   | 56383802    | 8    | 56463777    | 27   |
| 56359777    | 13   | 56361804    | 14   | 56383803    | 8    | 56463802    | 27   |
| 56359802    | 13   | 56361805    | 14   | 56383804    | 8    | 56463803    | 27   |
| 56360770    | 13   | 56362803    | 15   | 56383805    | 8    | 56463804    | 27   |
| 56360777    | 13   | 56362804    | 15   | 56384770    | 8    | 56463805    | 27   |
| 56360802    | 13   | 56362805    | 15   | 56384777    | 8    | 56465770    | 27   |
| 56361770    | 14   | 56363803    | 15   | 56384802    | 8    | 56465777    | 27   |
| 56361777    | 14   | 56363804    | 15   | 56384803    | 8    | 56465802    | 27   |
| 56361802    | 14   | 56363805    | 15   | 56384804    | 8    | 56465803    | 27   |
| 56362770    | 15   | 56365803    | 15   | 56384805    | 8    | 56465804    | 27   |
| 56362777    | 15   | 56365804    | 15   | 56385770    | 11   | 56465805    | 27   |
| 56362802    | 15   | 56365805    | 15   | 56385777    | 11   | 56466061    | 28   |
| 56363770    | 15   | 56367803    | 16   | 56385802    | 11   | 56467770    | 28   |
| 56363777    | 15   | 56367804    | 16   | 56385803    | 11   | 56467777    | 28   |
| 56363802    | 15   | 56367805    | 16   | 56385804    | 11   | 56467802    | 28   |
| 56365770    | 15   | 56370803    | 16   | 56385805    | 11   | 56467803    | 28   |
| 56365777    | 15   | 56370804    | 16   | 56451770    | 20   | 56467804    | 28   |
| 56365802    | 15   | 56370805    | 16   | 56451777    | 20   | 56467805    | 28   |
| 56366061    | 17   | 56371803    | 14   | 56451802    | 20   | 56469058    | 28   |
| 56367770    | 16   | 56371804    | 14   | 56451803    | 20   | 56470770    | 28   |
| 56367777    | 16   | 56371805    | 14   | 56451804    | 20   | 56470777    | 28   |
| 56367802    | 16   | 56372803    | 15   | 56451805    | 20   | 56470802    | 28   |
| 56369058    | 17   | 56372804    | 15   | 56458770    | 22   | 56470803    | 28   |
| 56370770    | 16   | 56372805    | 15   | 56458777    | 22   | 56470804    | 28   |
| 56370777    | 16   | 56373803    | 11   | 56458802    | 22   | 56470805    | 28   |
| 56370802    | 16   | 56373804    | 11   | 56458803    | 22   | 56471770    | 26   |
| 56371770    | 14   | 56373805    | 11   | 56458804    | 22   | 56471777    | 26   |
| 56371777    | 14   | 56374803    | 11   | 56458805    | 22   | 56471802    | 26   |
| 56371802    | 14   | 56374804    | 11   | 56459770    | 23   | 56471803    | 26   |
| 56372770    | 15   | 56374805    | 11   | 56459777    | 23   | 56471804    | 26   |
| 56372777    | 15   | 56375803    | 17   | 56459802    | 23   | 56471805    | 26   |
| 56372802    | 15   | 56375804    | 17   | 56459803    | 23   | 56472770    | 27   |
| 56373770    | 11   | 56375805    | 17   | 56459804    | 23   | 56472777    | 27   |
| 56373777    | 11   | 56376770    | 28   | 56459805    | 23   | 56472802    | 27   |
| 56373802    | 11   | 56376777    | 28   | 56460770    | 23   | 56472803    | 27   |
| 56374770    | 11   | 56376802    | 28   | 56460777    | 23   | 56472804    | 27   |
| 56374777    | 11   | 56376803    | 28   | 56460802    | 23   | 56472805    | 27   |

| PRODUCT NO. | PAGE | PRODUCT NO. | PAGE |
|-------------|------|-------------|------|
| 56473770    | 20   | 83697770    | 24   |
| 56473777    | 20   | 83697777    | 24   |
| 56473802    | 20   | 83697802    | 24   |
| 56473803    | 20   | 83697803    | 24   |
| 56473804    | 20   | 83697804    | 24   |
| 56473805    | 20   | 83697805    | 24   |
| 56474770    | 20   | 83698770    | 24   |
| 56474777    | 20   | 83698777    | 24   |
| 56474802    | 20   | 83698802    | 24   |
| 56474803    | 20   | 83698803    | 24   |
| 56474804    | 20   | 83698804    | 24   |
| 56474805    | 20   | 83698805    | 24   |
| 56481770    | 19   | 84990000    | 29   |
| 56481777    | 19   |             |      |
| 56481802    | 19   |             |      |
| 56481803    | 19   |             |      |
| 56481804    | 19   |             |      |
| 56481805    | 19   |             |      |
| 56482770    | 19   |             |      |
| 56482777    | 19   |             |      |
| 56482802    | 19   |             |      |
| 56482803    | 19   |             |      |
| 56482804    | 19   |             |      |
| 56482805    | 19   |             |      |
| 56483770    | 19   |             |      |
| 56483777    | 19   |             |      |
| 56483802    | 19   |             |      |
| 56483803    | 19   |             |      |
| 56483804    | 19   |             |      |
| 56483805    | 19   |             |      |
| 56484770    | 19   |             |      |
| 56484777    | 19   |             |      |
| 56484802    | 19   |             |      |
| 56484803    | 19   |             |      |
| 56484804    | 19   |             |      |
| 56484805    | 19   |             |      |
| 56485770    | 20   |             |      |
| 56485777    | 20   |             |      |
| 56485802    | 20   |             |      |
| 56485803    | 20   |             |      |
| 56485804    | 20   |             |      |
| 56485805    | 20   |             |      |
| 62102000    | 25   |             |      |
| 62101010    | 25   |             |      |
| 62101000    | 25   |             |      |
| 62108000    | 25   |             |      |
| 62109000    | 25   |             |      |
| 62201300    | 25   |             |      |
| 71134110    | 24   |             |      |
| 71132006    | 24   |             |      |
| 71132012    | 24   |             |      |
| 71132062    | 24   |             |      |
| 71132110    | 24   |             |      |





**Designer Metals™**  
inspiring brilliance

**Wood Trends™**  
renewing traditions

**Wrought Iron**  
forging artistry

**Custom Rodding  
& Basic Hardware**  
unique solutions